



GILBERT TOYS *for* 1952

See the New Toy Features!
See the New Anchor Blocks!
See the New Erector-Briks!

THE A. C. GILBERT COMPANY
ERECTOR SQUARE
NEW HAVEN 6, CONNECTICUT, U. S. A.

Export Division: The A. C. Gilbert Company
Fifth Avenue at 25th Street, New York 10, N. Y.

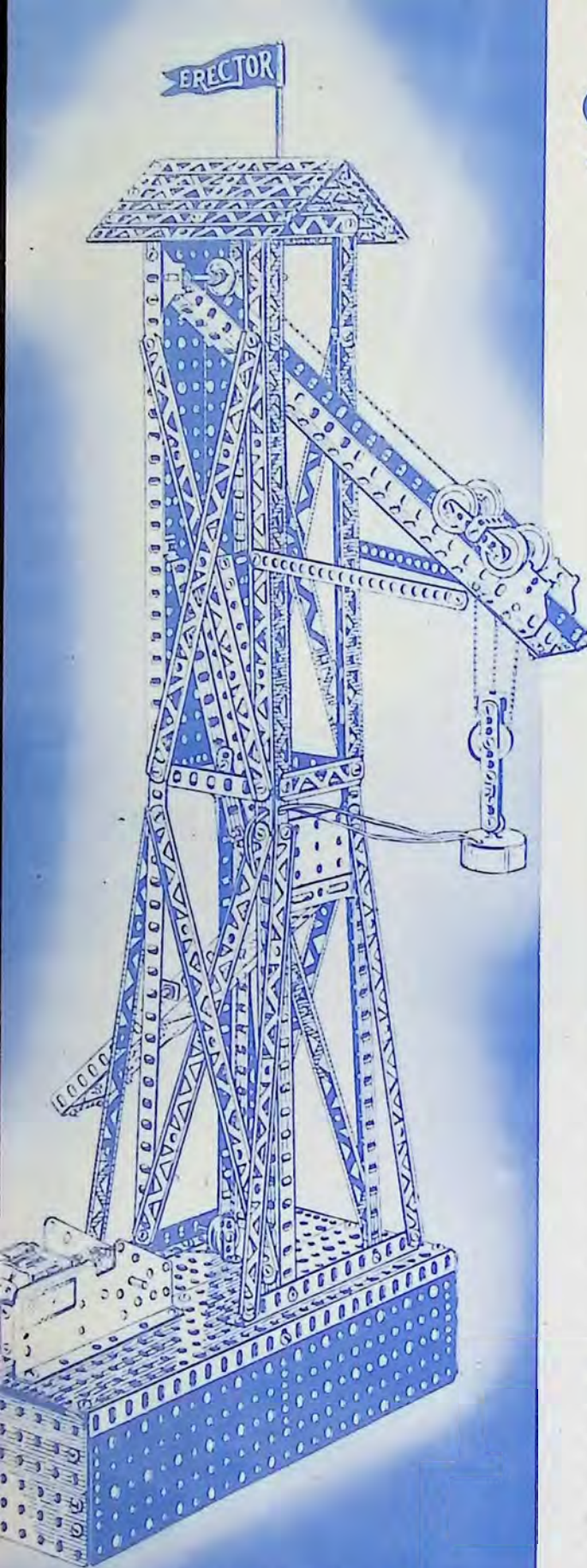

ELECTRO-MAGNET LOADER — ONLY ONE OF THE HUNDREDS OF INTERESTING ACTION MODELS WHICH CAN BE BUILT WITH ERECTOR.

Get More - Do More with **ERECTOR**[®]

THE WORLD'S GREATEST CONSTRUCTION TOY!

It's no wonder that ERECTOR — the household name known to millions throughout the world — is not only far, far better than any other construction set, but is also America's No. 1 toy. For ERECTOR is, literally, a THOUSAND toys, all rolled into one. You can DO more with ERECTOR because you actually GET more — more Girders, Gears and Shafts, more Couplings, Plates and Pulleys. The things which can be made with ERECTOR are nearly limitless. That's why people who buy toys think *first* of ERECTOR.

SQUARE GIRDER. Another key ERECTOR feature! Lengths of steel girders, rigidly locked together with nuts and bolts — the strongest engineering construction principle known! Only two nuts and bolts needed, yet girder edges interlock in vise grip. That's the secret of the ERECTOR building technique that enables you to build bridges capable of supporting more than 200 POUNDS! Only ERECTOR gives you the strength and ruggedness of real-life construction — only the square girder gives you a building part virtually impossible to crush, bend or twist. Ask a real construction engineer about the ERECTOR square girder. Let *him* tell you!



ERECTOR NUT-AND-BOLT CONSTRUCTION. Just as in real building, ERECTOR uses the strongest hold-together method known to man: nut-and-bolt construction. Nothing else can take the place of this tried-and-true technique which assures models that don't wobble, sway or bend. ERECTOR, first in America with nut-and-bolt construction, is still leader!

FLEX-O-MATIC DRIVE. Only ERECTOR has this unique feature that enables you to transmit power from your motor to the model in twists, loops or bends. This versatile flexible shaft makes your ERECTOR set even more useful, provides added fun.

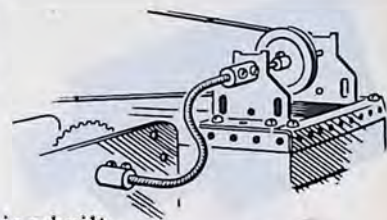

ERECTOR ENGINE. Powerful, precision-built Electric Engine, included with sets 6½ and up. The finest motor of its kind in the world (made by Gilbert, world's largest manufacturers of fractional horsepower motors) this rugged little engine will put many of your models into exciting action. Special gear train set-up provides four different speeds; by adding gears, more speeds can be gained. Gearing permits forward and reverse drive.



NEW PLATING PROCESS! Brand new plating method gives ERECTOR girders high, long-lasting lustre that makes them gleam like polished silver!

No. 1 1/2 ERECTOR—THE BUILDER'S SET

Here's extraordinary value! Four sizes of steel girders, 3 kinds of base plates and host of other parts sufficient to build score upon score of interesting models. Illustrated "HOW TO MAKE 'EM" book shows 72, including Baggage Truck, Swing, Prairie Schooner, Express Wagon, Crane Hoist, etc., but actually number is unlimited. Parts arranged for accessibility by builder. Set measures 13 1/2" long x 9 1/2" wide x 3/4" high. Boxed individually and packed 24 per carton. Shipping weight 35 lbs.

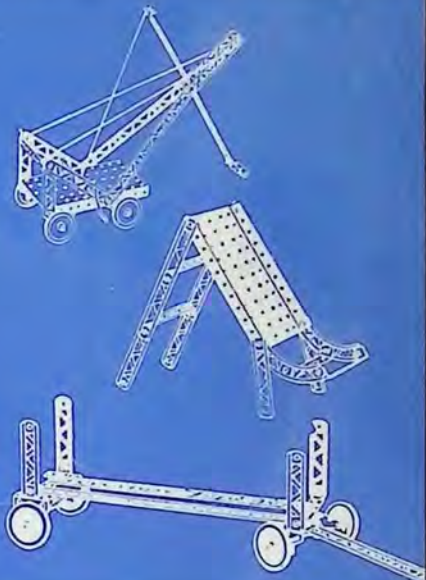

No. 2 1/2—ERECTOR—THE APPRENTICE SET

Builds hundreds of models, including Ferris Wheel, Trailer, Farm Wagon, Elevated Crane, Dutch Windmill, Portable Derrick, Inclined Railway and Foot Bridge, 10 1/2-inch girders come assembled in square girder form—strongest construction principle known. Wheels, pulleys, plates, screwdriver, etc., are also included. Illustrated "HOW TO MAKE 'EM" book. Set measures 18" long x 10" wide x 1 1/8" high. Boxed individually and packed 12 per carton. Shipping weight 29 lbs.



No. 4 1/2 ERECTOR—THE MOTORIZED SET

Two tiers of parts provide ample girders, plates, wheels, etc., to build such models as Windmill, Jig Saw, small Airplane Ride, Autogiro, Trip Hammer, Walking Beam Engine, Stamp Mill, Railroad Bridge and scores of others. Mechanical spring-wind Motor enables ERECTOR trucks to run under own power—no wires, no batteries. Also operates Hoist, Crane, Ferris Wheel and other models. Miniature house serves as Bridge Tender's shack, Ticket Seller's booth, etc. Profusely illustrated "HOW TO MAKE 'EM" book included. Set measures 18" long x 10" wide x 2 3/8" high. Boxed individually and packed 6 per carton. Shipping weight 33 lbs.

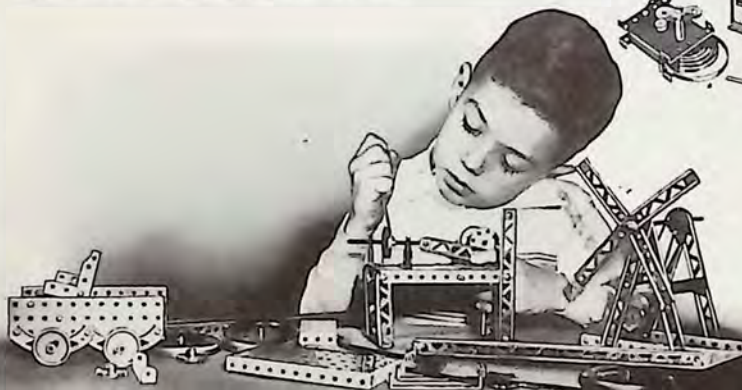

ERECTOR

First Choice for 42 Years!

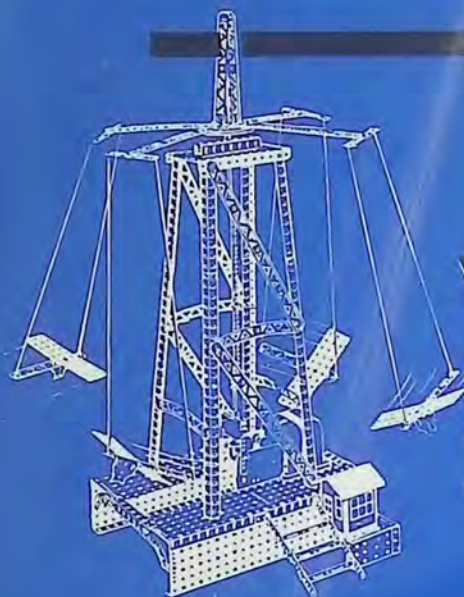

No. 6 1/2 ERECTOR— THE ELECTRIC ENGINE SET

BUILDS THE THRILLING AIRPLANE RIDE

It's easy to understand why this big ERECTOR set, with its gleaming array of more than 350 parts, has consistently remained one of the most popular ever made. Jam-packed with Girders, Gears, Pinions, Wheels, Plates, Bolts, etc., it has a double tier of trays nested in a sturdy hinged-cover cardboard box. Powerful Electric Engine gear train runs in forward and reverse, has multiple speed combinations. All-steel Bridge Tender's Shack finished in bright colors. Set builds such models as the Lift Bridge, Windmill Pump, Airplane Beacon, Pile Driver, Delivery Truck, Hoist, Elevator and scores of others. Also included in set is extraordinary Magic-Twist flexible coupling that enables you to transmit power from the motor to the model in bends, twists and loops. Box is 18" long x 10" wide x 3" high. Big illustrated book describes in step-by-step fashion how to put together models. Boxed individually and packed 3 per carton. Shipping weight 27 lbs.

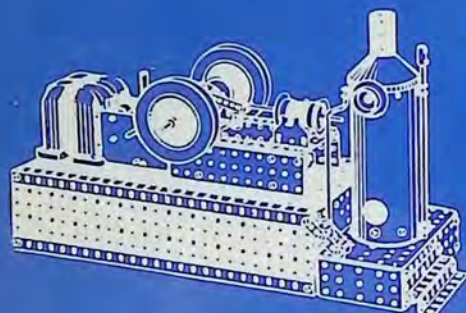

No. 7 1/2 ERECTOR—THE ENGINEER'S SET

BUILDS THE WALKING BEAM ENGINE

Over 360 all-metal parts, including a powerful Electric Engine whose gearing will produce a variety of speeds, plus reverse or forward operations, make up this huge ERECTOR set. Engineering marvels like the Bascule Bridge, Hoisting Engine, Derrick, Air Compressor, Steam Plant, Twin Cylinder Engine and many, many others can all be built right in your own home. Polished steel boiler and Engineer's shack provides even greater value. By adding gear arrangements, Engine can be made to produce scores of varied speeds and will turn vertical as well as horizontal shafts. A set made for years of fun—and real usefulness. Extra strong composition chest, with hinged metal clasp cover, measures 19" long x 11" wide x 3 1/4" high. Boxed individually and packed 3 per carton. Shipping weight 32 lbs.



No. 8 1/2 ERECTOR—THE ALL-ELECTRIC SET

BUILDS THE COLORFUL FERRIS WHEEL

Nearly 16 POUNDS of Girders, Gears, Pinions, Plates, Wheels and other ERECTOR parts make up this massive set, complete with sturdy hinged-cover cabinet. In addition to a 4-speed forward-and-reverse gearing in Electric Engine, you'll find a string of electric lights to illuminate finished models PLUS an electro-magnet so powerful it grabs up steel girders before it touches them! With this set you can make such exciting models as a Magnet Crane, Oil Drilling Rig, Ferris Wheel, Portable Derrick, Operating Elevator, Airplane Beacon, Cantilever Bridge and scores upon scores of others, including over 100 engine-driven, illuminated models alone! Set has Flex-O-Matic magic coupling to transmit motor power in twists and loops. Huge chest, finished in bright red, measures 20 1/4" long x 12 1/4" wide x 2 3/4" high. Boxed individually and packed 3 per carton. Shipping weight 48 lbs.

No. 10½ ERECTOR—THE AMUSEMENT PARK SET

BUILDS PARACHUTE JUMP and MERRY-GO-ROUND

What a huge ERECTOR assortment confronts you when you open the lid of this big all-steel hinged cabinet and see the mass of parts, arrayed in a double tier. Here, indeed, is a set that lasts for a lifetime, can be handed from father to son. Nearly 25 POUNDS of parts and equipment; over 300 toys all rolled into one! You can build a colorful carnival setting that will be the envy of the neighborhood: Parachute Jump, Merry-go-Round, Sideshow booths, etc., PLUS such action models as the Giant Power Plant, Dutch Windmill, Traveling Crane, Universal Crane, Double Cylinder Horizontal Engine, Hammerhead Crane with Magnet and many, many other kinds. Models swing into action when connected with the 110 volt Electric Engine with forward-and-reverse operation and variety of geared speeds. Parts include Boiler and Fly Wheel equipment, electro-magnet, horses, Bridge Tender's shack, and string of lights. Big sheet steel cabinet measures 22" long x 13½" wide x 2¾" high. Packed 1 per carton. Shipping weight 28 lbs.

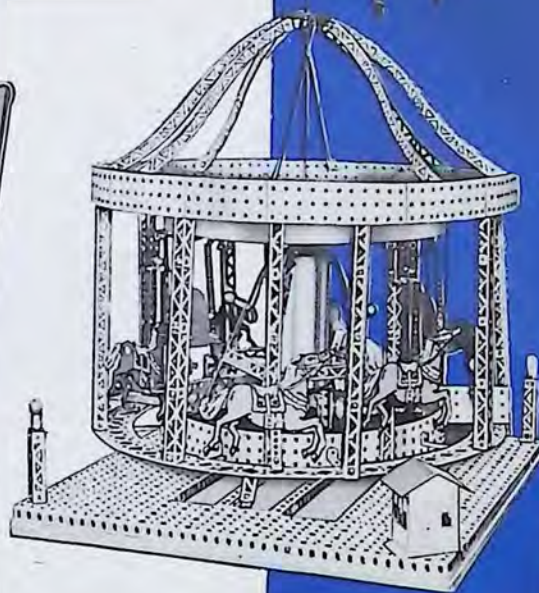

The
MERRY-GO-ROUND
and
PARACHUTE JUMP
shown above are only
two of many
exciting action models
you can build with
No. 10½ ERECTOR.



No. 5 ILLUMINATION KIT. Gives both stationary and action Erector models twice the fun! Four red, 4 green bulbs and 8 sockets plus ample wire, etc. Use with 7-15 volt transformer. For all Erectors. Boxed individually and packed 6 per carton. Shipping weight 3 lbs.

No. 7 SMOKE AND CHOO-CHOO KIT. Last word in realism! Install on Erector hoists, cranes, etc., and make them puff thick, harmless smoke when they're in action. For 7½ Erector and up. Use with 7-15 volt transformer. Boxed individually and packed 6 per carton. Shipping weight 5 lbs.

Satisfy the child's creative urge

with the

FASCINATING and COLORFUL

Junior ERECTOR

Every child, from the age of 2, loves to make things with his own hands. Child psychologists say this desire for creativeness should be encouraged as an aid in child development. Although construction sets are ideal for this purpose, most of them are too complex and require too much coordination for average children. Not so JUNIOR ERECTOR. This fascinating Gilbert toy has been scientifically designed and tested in child clinics for 2 to 6 age groups. Because models are made by fitting a hollow tube OVER a knob, youngsters find parts easy to handle. Ordinary construction sets require a tube to be pushed INTO a hole—a difficult feat for tiny hands. Furthermore, all parts are brilliantly colored and same-length tubes are the same color. Children simply match shades as per illustrated four-color instruction book.

No. 4 JUNIOR ERECTOR

Builds more models and larger models from greater assortment of parts. Makes Beach Boat, Fire Engine, Derrick, Trestle Bridge, Ferris Wheel, Windmills, Trucks and many others. Packed in the colorful box are tubes, connectors, bearings, locks, propeller blades and rubber tires (for converting connectors into realistic spoked wheels or pulleys). Four color "HOW TO MAKE 'EM" book. Set measures 20½" long x 13¼" wide x 1¼" high. Boxed individually and packed 6 per carton. Shipping weight 12 lbs.

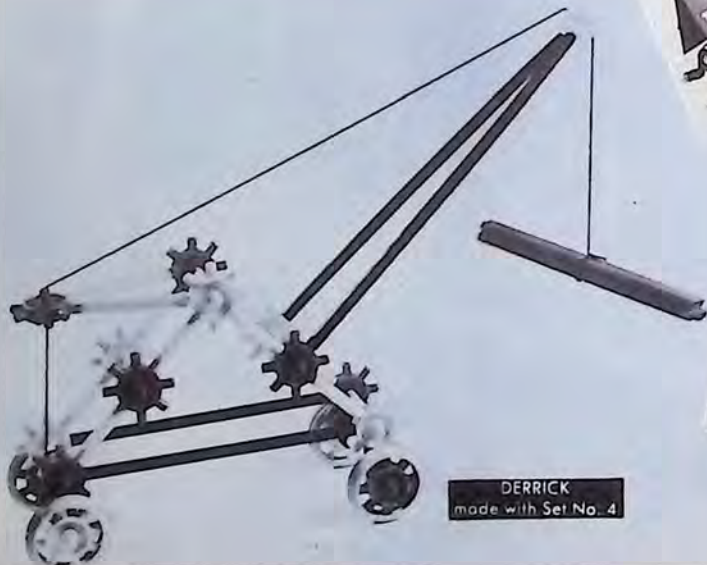

DERRICK
made with Set No. 4



No. 2 JUNIOR ERECTOR

Non-snagging, colorful (red, yellow, green, white) plastic parts fit together to make such models as Lounge, Ladder, Swing, Windmill, Table, Wheelbarrow, Chair, Bridge, Airplane and small House. With practice children learn to design own models. Ample assortment of tubes, connectors, bearings and locks. Full color "HOW TO MAKE 'EM" book. Box measures 13½" long x 9¾" wide x 1¼" high. Boxed individually and packed 12 per carton. Shipping weight 12 lbs.



EACH JUNIOR ERECTOR SET BUILDS SCORES OF INTERESTING MODELS!

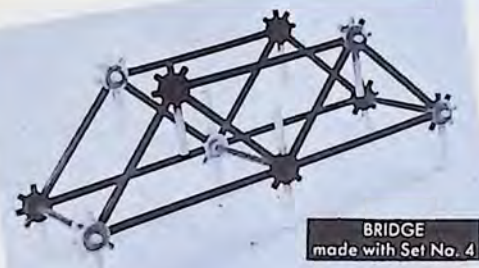

BRIDGE
made with Set No. 4

AIRPLANE SPIN
made with Set No. 10



BEACH BOAT
made with Set No. 4

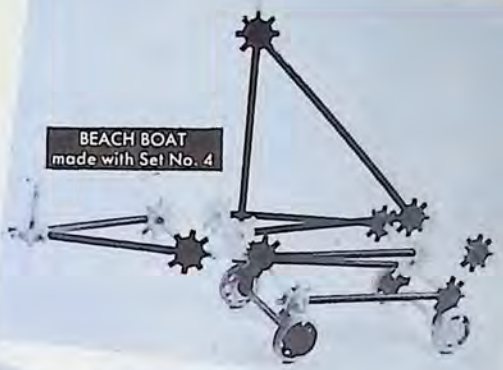

WATER WHEEL
made with Set No. 10



WINDMILL
made with Set No. 10



LADDER
made with Set No. 2



AIRPLANE
made with Set No. 2



SWING
made with Set No. 2



FERRIS WHEEL
made with Set No. 10

No. 10 JUNIOR ERECTOR

Advanced set which will make literally hundreds of models, including Lift Bridge, large House, Water Wheel, Merry-go-Round, Well Driller, giant Ferris Wheel and many, many others. Ideal set for developing child's creativeness, confidence and pride of achievement. Generous parts selection includes tubes, connectors, bearings, locks, propeller blades, horses, etc. Top tray removable. Four color "HOW TO MAKE 'EM" book. Hinged box measures 20 1/2" long x 13 1/4" wide x 2 1/2" high. Boxed individually and packed 3 per carton. Shipping weight 14 lbs.

BACK AGAIN!

Smooth Marble-like Finish...

GILBERT ANCHOR BLOCKS



No. 2

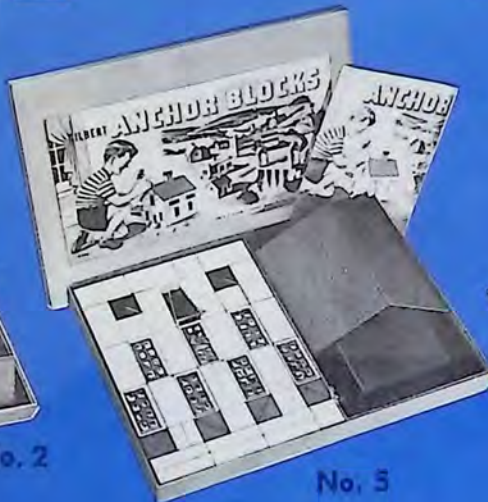

No. 5



No. 10

No. 2 ANCHOR BLOCK SET

Here's a compact set with just the right number of Anchor Blocks and parts to enable smaller children to build interesting but not complicated models. Typical of the scores of models which can be put together by two- and three-year olds is the colorful Bus Station, shown on this page. Set has 24 Anchor Blocks, all properly weighted for piling, and includes whole and half sizes plus a chimney and four peak sections. Completing the set are a roof and illustrated Building Book. Box measures 10½" x 9" wide x 1¼".

No. 5 GILBERT ANCHOR BLOCK SET

Anchor Blocks, an all-time favorite with 2 to 7 year-olds for over a century, is back once more in '52 with features which make it even better! New material gives Anchor Blocks appearance and feel of polished marble. And it's virtually unbreakable; won't crack, chip, crumble or shatter! Hundreds and hundreds of models can be built with the Blocks, which come in variety of sizes and shapes: four different cubes and rectangles plus angle blocks, chimneys and spires. Roof is deeply embossed shingle-type. Windows and doors are embossed foil lamination. Most important, new Anchor Blocks are JUST RIGHT for piling; not too light, not too heavy. Can be used out-of-doors because Blocks will clean with damp cloth. Unaffected by moisture. Large illustrated Building Book included. Set measures 13⅜" long, 9½" wide, 1-3/16" high. Packed 12 per carton.

No. 10 ANCHOR BLOCK SET

Two big tins, packed with enough Anchor Block material to make stores, schools, houses, castles, forts—literally, almost anything the child's imagination can create. Blocks can be handled easily by even small children, yet have the weight and heft to pile without toppling. New "marble" material will not soil or dirty like wood, can thus be used outdoors. Practically unbreakable; will retain lustre and wonderful smoothness after even roughest use. Handsome chest in which double trays are packed is made of natural-finish basswood with brass-plated hardware. Each tray contains 1" square, 1" x 1" x ½", 1" x 1" x 2" and 1" x 2" x ½" Blocks plus Angles, Chimneys, Spires and Roofs. Three colors: red, green, white marble. Windows and doors are embossed foil, laminated. Big illustrated Building Book included. Chest is 14½" long, 8½" wide, 3" high. Packed 6 per carton.

CHURCH
No. 5 SET



HOUSE
No. 10 SET



BUS STATION — No. 2 SET

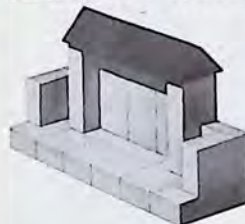

LIBRARY
No. 10 SET



Build These Models and HUNDREDS More
with ANCHOR BLOCKS

Highly Polished... Beautiful Colors... Right for Piling!

GILBERT **ERECTOR-Brik** SETS

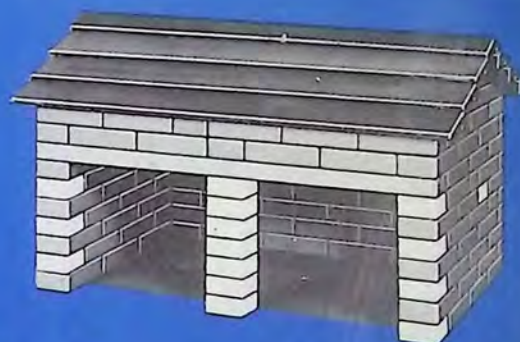
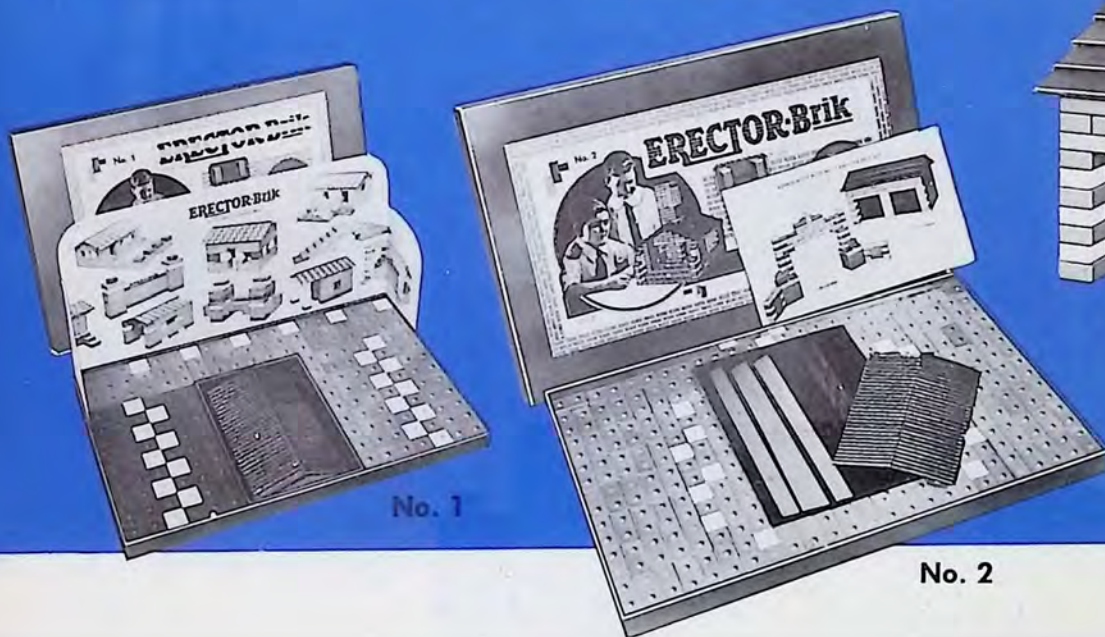

TWO CAR GARAGE
made with Set No. 2

No. 2

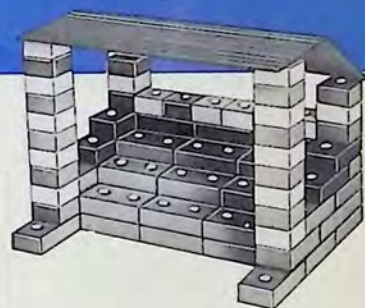

GRAND STAND
made with Set No. 1

**Exclusive Lock-Together Construction . . .
Brilliant Colors . . . Won't Chalk, Chip, Shatter
or Crumble . . . Ideal for 2 Year-olds and up.**

No. 1 ERECTOR-BRIK SET

Only the imagination of the youngster limits the number of DIFFERENT kinds of houses, forts, palaces, etc., which can be built with this Erector-Brik set. New exclusive material makes Briks wonderfully smooth and break-proof. Brilliant reds and marble whites. Set has 112 Briks and realistically-molded corrugated type roof, measuring 6 3/4" x 5". All Briks have patented lock-together construction: half-round knobs fit into knob holes, enable you to build straight and true, with no toppling. Measures 15 1/2" long, 10" wide, 1" high. Packed 12 per carton.

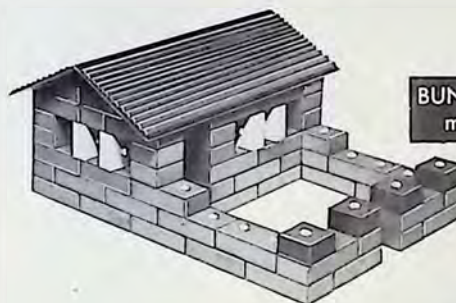

BUNGALOW AND WALL
made with Set No. 1

No. 2 ERECTOR-BRIK SET

Total of 273 Briks, including whole, half and quarter sizes, plus a corrugated roof, 6 molded roof pieces, 4 molded lintels and realistic acetate windows enable the young builder to create an unlimited number of models, from simple cottages to complex palaces. Special locking principle (Brik knobs nest into holes, securing one Brik to another) means that walls can be built without toppling, can be laid in a straight line. Lintels also double as truss beams (for bridges), as joists (for buildings) and as platforms. Package measures 20 1/2" long, 13" wide, 1 1/4" high. Packed 3 per carton.

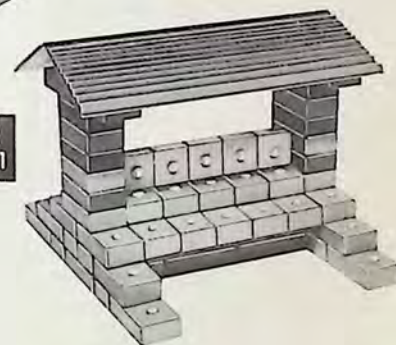

WAITING SHELTER
made with Set No. 1



DOUBLE SPAN BRIDGE
made with Set No. 2

**ONLY ERECTOR-BRIK HAS THE
GREAT INTERLOCKING FEATURE!**

GILBERT CHEMISTRY SETS

The Sets that Build a Career!



NOW, For the First Time

A Chemistry Set That Needs No Heat

For Young Boys!

No. 1 GILBERT CHEMISTRY— "NO HEAT" BEGINNER'S OUTFIT

The set that opens a brand new market in the chemistry set field: a complete laboratory that **REQUIRES NO HEAT** in performing any of the experiments listed in the big 72-page illustrated manual. That means that youngsters in the 7-8 age group can now use a chemistry set without needing lamps, candles, burners, etc., for conducting experiments. Set enables user to perform 118 experiments, including Magic Blueprint, Elastic Egg, Rock Salt, Vanishing Cream, Furniture Polish, Invisible Ink, Magic Pen, Carbon Paper and many others. Contains 18 pieces of apparatus and chemicals: Zinc Oxide, Sodium Carbonate, Diglycol Stearate, Ferric Ammonium Sulphate, etc., plus test tubes, spoon, shovel, self-display test tube rack and other equipment. Brown, lightproof pharmaceutical-type bottles hold chemicals. Set measures 18" long, 10" wide, 1 1/8" high. Boxed individually and packed 12 per carton. Shipping weight 28 lbs.

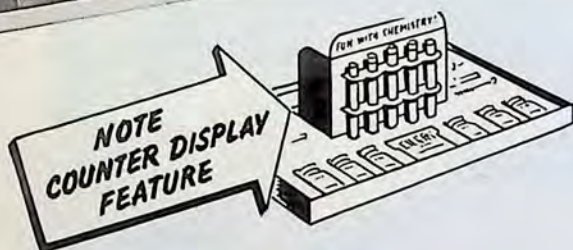

No. 3 GILBERT CHEMISTRY JUNIOR LABORATORY

Over 223 fascinating experiments can be performed with the apparatus and chemicals packed with this full-sized laboratory. You can make mucilage, casein, printer's ink, perfumed soap, magic fire ink, bayberry candle, purple flame, black lacquer and scores upon scores of other things with the 26 pieces of chemicals and equipment. Steel test tube rack tilts forward for easy accessibility; lightproof bottles include Ammonium Chloride, Sodium Carbonate and other essential chemicals. Laboratory-type chest opens to 20 1/4" width, folds to 10 1/8" wide x 11 3/4" high x 1 1/2" deep. Big 8" x 10" "FUN WITH GILBERT CHEMISTRY" book has 84 pages, fully illustrated throughout. Boxed individually and packed 6 per carton. Shipping weight 17 lbs.

DEALERS! TIE-IN WITH THIS GILBERT CHEMISTRY CONTEST!

The annual Gilbert Hall of Science contest, awarding \$200.00 in cash prizes in the field of Chemistry or Microscopy, gives you another "plus" in promoting retail sales of Gilbert Chemistry sets. Schools, Boy Scout groups, boys' club organizations, etc., each year provide thousands of entrants — and customers for Gilbert Chemistry sets. Watch four-color consumer catalog for full details.

SETS SHOWN ON THIS PAGE UNFOLD TO MAKE A COMPLETE LABORATORY.

No. 7 GILBERT CHEMISTRY SENIOR LABORATORY

Jam-packed with enough chemicals and apparatus to perform 379 thrilling experiments! Three shelves of lightproof brown bottles, totaling 21 different kinds, plus 14 other chemicals arranged in steel test tube storage racks, provide ample material for home laboratory work. Alcohol lamp, glass stirring rods, funnel, etc., are included in list of professional equipment. In addition to 84-page "FUN WITH GILBERT CHEMISTRY" book, another book, "GILBERT HOME CHEMISTRY" tells about experiments which can be done with every-day materials. Still another booklet describes 80 experiments in the fascinating field of Glass Blowing. Big, two-compartmented hinged chest stands 11½" high and opens to 20¾" width. Apparatus and chemicals total 67 pieces. Set folds to 9¾" wide x 11½" high x 2¾" deep. Boxed individually and packed 3 per carton. Shipping weight 20 lbs.

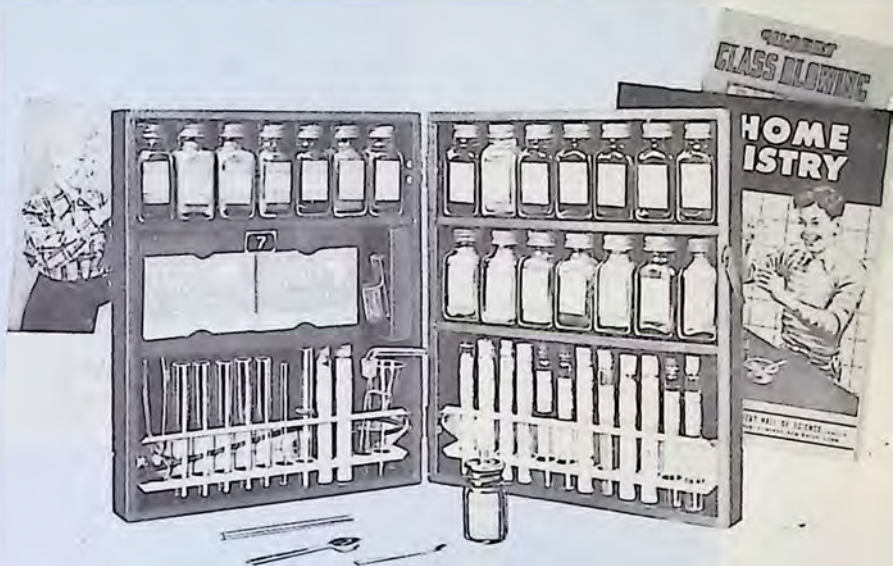

No. 11 GILBERT CHEMISTRY ATOMIC ENERGY SET

This massive Gilbert Chemistry Set, measuring nearly 3½ feet when opened, is not only a fully-equipped chemical laboratory, but also has apparatus and instructions in the fascinating field of Atomic Energy! Huge assortment of 108 chemicals and equipment enables you to perform 480 interesting experiments listed in the giant 128-page illustrated book "FUN WITH GILBERT CHEMISTRY," plus FOUR other books: "ATOMIC ENERGY," "CHEMISTRY IN THE

HOME," "GLASS BLOWING," and "CHEMICAL MAGIC." Atomic Energy apparatus includes Spintharoscope (enables you to watch disintegration of atomic particles speeding at 10,000 MILES PER SECOND) plus safe radioactive ore. List of experiments almost endless: Turn water to wine, ink to water, make a magic rose, etc., etc. Four-compartmented hinged chest extends to 40½" opened. Closes to 20" long, 11½" high, 2¾" wide. Packed 1 per carton. Shipping weight 14 lbs.



HAS NEW ATOMIC ENERGY FEATURE! With Spintharoscope, above, you can view the disintegration of atomic particles racing at speeds over 10,000 miles per SECOND!

GILBERT MICROSCOPE SETS

- MAGNIFIES UP TO 450 TIMES ACTUAL SIZE!
- POLAROID DEVICE REVEALS WONDERLAND OF COLOR!
- HIGHLY-POLISHED OPTICAL LENS FOR SHARP VIEW!



No. 20 GILBERT MICROSCOPE SET

Huge scientist's laboratory, featuring a powerful precision Microscope which magnifies objects 120, 200 and 450 TIMES ACTUAL SIZE! Turret mechanism permits magnifications to be changed in a jiffy. Exclusive Gilbert Polaroid device brings out riot of specimen colors, hidden from view with ordinary 'scopes. Hues are breathtaking! Two steel test tube racks contain variety of chemicals and specimens; slide-out drawers contain assortment of slides and parts. Equipment also includes top stage and substage light for illumination of specimens—just like professional 'scopes. Dri-Electric Power Pack provides power source. Hand lens and alcohol lamp complete apparatus. Two illustrated manuals included. Hinged chest measures 20" long x 3-7/16" wide x 14" high when opened. Boxed individually and packed 3 per carton. Shipping weight 22 lbs.

\$200.00 in Cash Prizes!

Another promotion "plus" that makes Gilbert Microscope Sets the fastest-selling of all! To the boy or girl doing the most important research in the fields of Microscopy or Chemistry, a first prize of \$100.00 in cash will be awarded, plus 10 other prizes. Full details in Gilbert Fall color catalog.

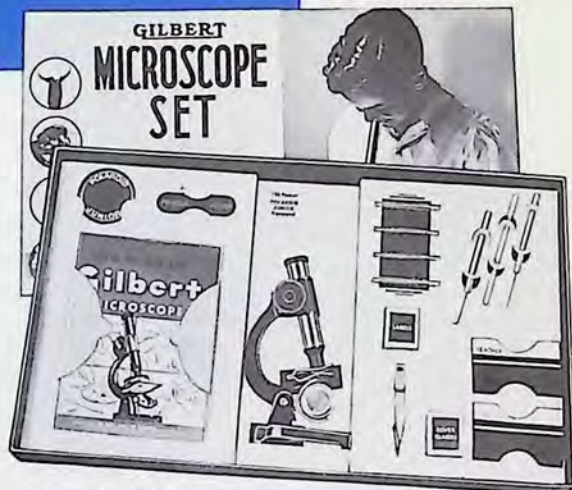

No. 5 GILBERT MICROSCOPE SET

Accurately ground, optical lens Gilbert Microscope magnifies 60 TIMES ACTUAL SIZE and has exclusive Polaroid device which brings out a wonderland of colors impossible to see with ordinary 'scopes. Dissecting equipment, assortment of slides, specimens, etc., included with set. Microscope has adjustable focusing knob, slide clips and mirror. Big 80-page illustrated book describes experiments. Set measures 18" long x 10" wide x 2½" high. Boxed individually and packed 6 per carton. Shipping weight 14 lbs.



No. 8 GILBERT MICROSCOPE SET

Semi-professional set! Microscope, with high resolving power and a revolving turret, magnifies specimens 60, 90 and 210 TIMES ACTUAL SIZE. Lens are optical glass, highly polished and precision ground. Focusing can be done quickly, sharply; field of view is large. With Polaroid attachment gorgeous colors come in view. Test tubes, forceps, dozen chemicals, slides, hand lens, etc., make complete laboratory. Set is 18" long x 10" wide x 2½" high. Boxed individually and packed 6 per carton. Shipping weight 20 lbs.

GILBERT TOOL CHESTS

Quality tools to build a Club House, Tree House, Workshop Bench
— even a seagoing Boat! Specially built to fit young hands.



No. 14 GILBERT TOOL CHEST 27-PIECE SET

Everything for the young carpenter! Durable, hinged chest contains Cross-cut, Coping and Keyhole saws, large Brace, Bits, Mallet, Screwdrivers, Awl, Chisel, Level, Pliers, Utility Can, Hammer, Triangle, Trowel, Putty Knife, Plumb Bob, Wrench, Plane and other tools. Chest measures 18 $\frac{5}{8}$ " x 10 $\frac{5}{8}$ " x 3". Packed 3 per carton. Shipping weight 29 lbs.

No. 9 GILBERT TOOL CHEST 21-PIECE SET

Best tool chest value in its price range, by far! Sturdy, hinged Cover Chest. Contains Brace, Saw, Screw Driver, Putty Knife, Awl, Pliers, Dividers, Chalk, 12" Level, Sandpaper Block, Hammer, Triangle, Try-Square, 12" T-Square, Sandpaper supply, Gimlet Bit, Wrench, Plane, Plumb Bob, Utility Can. Chest 16 $\frac{5}{8}$ " x 8 $\frac{3}{4}$ " x 3". Packed 6 per carton. Shipping weight 40 lbs.

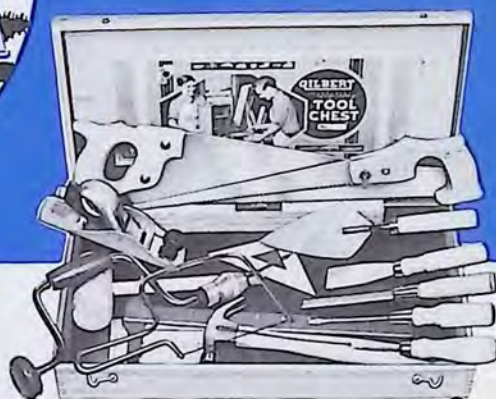

No. 3 GILBERT TOOL CHEST 11-PIECE SET

Heavy gauge hinged cover steel chest, jam-packed with tools, makes this Gilbert Tool Chest set a real value! Contains 4" Screw Driver, 10" Saw, Mallet, cast Pliers, Sandpaper Block, 6" metal Triangle, Hammer, 45° wood Triangle, 12" Ruler, Utility Cup, Sandpaper supply. Steel chest is 14" x 7 $\frac{3}{4}$ " x 2 $\frac{1}{4}$ ". Packed 6 per carton. Approx. shipping weight 24 lbs.



No. 16 GILBERT TOOL CHEST 30-PIECE SET

Huge assortment of tools for the advanced junior carpenter! Big basswood chest contains array of Saws, Brace & Bit, saw blades, Mallet, Screw Drivers, Awl, Scratch Gauge, Level, Chisels, Pliers, Hammer, T-Square, Putty Knife, Utility Can and Nails, Triangle, Plumb Bob, Sandpaper Block, Wrench, large Plane and many, many other tools. Almost any building project can be handled with this set. Chest measures 20 $\frac{1}{2}$ " x 12 $\frac{1}{4}$ " x 3". Packed 3 per carton. Shipping weight 39 lbs.

No. 5 GILBERT TOOL CHEST 12-PIECE SET

Handsome all-steel hinged chest serves for real "on-the-job" work! Set comprises Screw Driver, 10" Saw, Mallet, Pliers, Sanding Block, 6" metal Triangle, Hammer, 45° Triangle, 12" T-Square, Sandpaper supply, Plumb Bob, Utility Can. Chest measures 14 $\frac{1}{2}$ " x 8 $\frac{1}{2}$ " x 3". Packed 6 per carton. Shipping weight 24 lbs.

GILBERT No. 3A ECONOMY TOOL CHEST! 11-PIECE SET

Compare tool assortment and low price with other sets and you'll agree there's no buy like it anywhere! Same quality tools as No. 3 set, left, but packed in heavy carton board chest with hinged cover, measuring 14" x 7 $\frac{3}{4}$ " x 2 $\frac{1}{4}$ ". Packed 6 per carton. Approx. weight 22 lbs.



GILBERT MYSTO MAGIC SETS

No. 1 1/2 GILBERT MYSTO MAGIC

Every trick in this set has been made famous by conjurers of international repute! Each one is a real "stopper," designed to amaze any audience, yet all eleven tricks are easy to master. Partial list includes Vanishing Handkerchief, Cut and Restore Paper Ribbon, Mystic Slide, Magic Keys, Phantom Cards, Vanishing Rabbit and many others. Set measures 18" x 10" x 1 1/4". Boxed individually and packed 12 per carton. Shipping weight 16 lbs.

No. 2 1/2 GILBERT MYSTO MAGIC

This assortment of tricks from all parts of the world will enable you to put on a magic show that will astound your friends—and enable you to earn handy spending money! Contents includes the Sphinx Card Trick, Vanishing Rabbit, Magic Keys, Multiplying Billiard Balls, Jumping Peg, Svengali Mind Reading Wonder and several others. Set also includes make-up Mustache Kit and Goatee, plus huge show poster. Box is 20 5/8" x 13 3/8" x 1 1/4". Boxed individually and packed 6 per carton. Shipping weight 14 lbs.

No. 5A GILBERT MYSTO MAGIC

A huge assortment of tricks from all parts of the globe! After only a short practice session you'll be performing such tricks as the Passe Passe Coin Trick, Acrobatic Wedding Ring, Vanishing Handkerchief, Cups and Balls, Multiplying Billiard Balls, Vanishing Rabbit, Magic Keys and many, many others. Set includes moustache-goatee make-up kit and colorful poster. Hinged box measures 20 5/8" x 13 3/8" x 2 1/4". Packed 3 per carton. Shipping weight 15 lbs.

No. 25 GILBERT MYSTO MAGIC SHOW

A super professional magician's outfit, complete with top hat (assembles in few minutes) and theatrical drop curtain. For a show, set it up as illustrated with legs supporting set. When finished, legs fit inside and cover closes to form suitcase for traveling. Contains scores of tricks: partial list includes Topsy Turvy Match, Passe Passe Bottle Trick, Jumping Peg, dozens of card tricks, Vanishing Coin, Galloping Dime, mind reading tricks, Vanishing Whiskey Glass, Ball and Vase Trick, Chinese Rings, Fake Quarter, Four Ace Card Trick and many, many others. Includes five big illustrated books of instructions. Set measures 25 1/4" wide x 4 5/8" high x 16 1/2" deep. Packed 1 per carton. Shipping weight 15 lbs.

No. 6 GILBERT MYSTO MAGIC

Brand new set for '52 with FEATURES NEVER BEFORE INCLUDED IN ANY MAGIC SET ANYWHERE! In addition to a huge assortment of tricks from all parts of the globe, there are FIVE big books: "Be a Ventriloquist," "The Art of Juggling," "Handkerchief Tricks," "Knots and Splices" and "Mysto Magic" book. Heretofore, only expensive library tomes have dealt with Ventriloquism; with this Gilbert set you get a complete Ventriloquism course plus "Happy," the hand puppet. Four juggling balls, specially designed for boys, plus illustrated book enable you to practice this popular art. Big list of tricks includes the Magician's Rhapsody, the Vanishing Whiskey Glass, Acrobatic Wedding Ring, Passe Passe Coin Trick, a number of card tricks and many, many others. Make-up Kit and poster included. Hinged cover box is 20 5/8" x 13 3/8" x 2 1/4". Packed 3 per carton. Approx. weight for shipping 16 lbs.



No. 6



No. 1 1/2



No. 2 1/2



No. 5A



No. 25



GILBERT PUZZLE SETS



No. 1032

No. 1032 GILBERT PUZZLE SET

There's fun and entertainment for young and old alike with the nearly two-dozen twisters in this big Gilbert assortment. You'll laugh as you watch your friends try to solve the puzzle of the Heathen Rings, the Conjuring Rings, the Twin Links, etc., because it's a cinch when you know how. Ideal for puzzle parties, rainy afternoons, auto trips and other occasions. Illustrated booklet provides solutions. Set measures 18" long x 10" wide x 1 1/4" high. Boxed individually and packed 12 per carton. Shipping weight 19 lbs.



No. 1033

No. 1033 GILBERT PUZZLE SET

Giant de luxe set, combining 20 wire puzzles and six clever puzzle tricks. You'll have hour after hour of enjoyment solving the Vampire Puzzle, the Wishbone Puzzle, the Lucky Horseshoe, Hungry Pup, Shamrock Puzzle, Topsy Turvy Rivets and many, many others. Wire puzzles made of heavy-gauge steel, plated to resist rust. Set measures 20 1/2" long x 13 1/4" wide x 1 1/4" high. Boxed individually and packed 6 per carton. Shipping weight 18 lbs.

No. 1034 GILBERT PUZZLE SET

New set of six intriguing teasers, handsomely finished in full color and packaged as a counter self-seller. Just the thing to liven up a party, keep the children amused or while away some leisure time. You'll have all kinds of fun Playing Golf, competing in the great Turtle Race, acting as Atomic Bombardier, lifting (with Leo the Strong Man) the mammoth bar bell, solving the Topsy-Turvy Rivets puzzle and nailing the Lucky Horseshoe. There's a trick way to do each one! Clear plastic dome-type puzzles have 3 1/2" diameter. Package is 13 1/2" x 9 1/2" x 1 1/2". Boxed individually and packed 12 per carton.

No. 1040 GILBERT PUZZLE SET

Whether you're 7 or 70, you'll get a barrel of enjoyment from this brand new Gilbert Puzzle set that has a complete new assortment of bafflers and teasers. You'll be regaled when you try them on your friends, because each puzzle has a "secret" solution that only YOU know! You can trick them with the Chinese Finger Trap and the Magic Buttonhole Pencil. You can fool them with the Boomerang Puzzle, the Mystic Propeller and the Snapper. Feature is the ancient Hindu Pyramid Puzzle, one of the most remarkable even seen! Set has 12 puzzles in package 18" x 10" x 1 1/4". Boxed individually and packed 12 per carton.

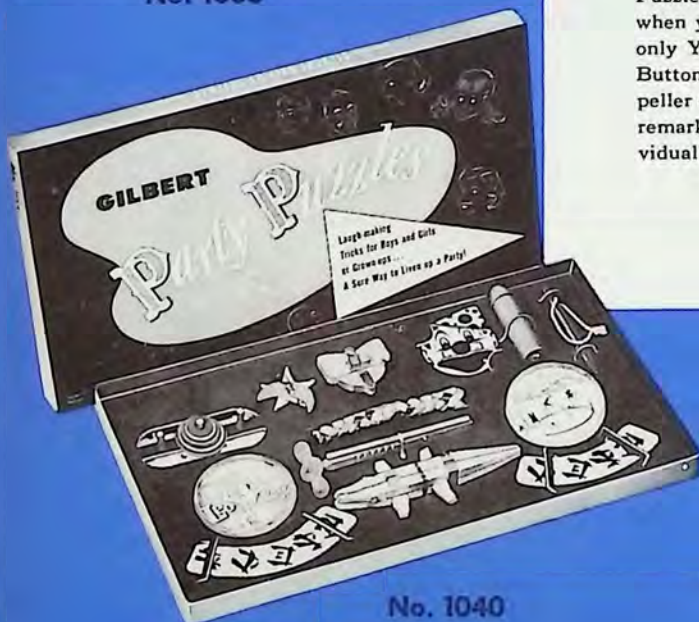

No. 1040



No. 1034

GILBERT ATOMIC ENERGY LAB

No. U-238 ATOMIC ENERGY LAB

Possibly the greatest educational toy of all time! With its instruments you can study and UNDERSTAND the atom—what it does, its reactions, etc. Useful in providing training for nuclear physics career. All instruments are ACCURATE and PRECISE. Not just "toys", but real laboratory equipment developed in conjunction with top University nuclear physicists. Many sets already in use in college classrooms. Instruction book written by Dr. Ralph E. Lapp, distinguished scientist, lecturer and author. Lab includes Geiger Counter, Gilbert Cloud Chamber, Electroscope, Spintharoscope, Nuclear Spheres, Alpha, Beta and Gamma radiation sources and Uranium-bearing ores. Two booklets, "Prospecting for Uranium" and "Gilbert Atomic Energy Instructions" also packed with set. Sturdy hinged chest has convenient suitcase-type carrying handle. Measures 25" long x 16½" wide x 5" high. Packed 1 per carton. Shipping weight 11½ lbs.



No. U-239 GEIGER COUNTER

(Included with Atomic Energy Lab and also sold separately)

Every Civil Defense unit, every home and every factory in areas where radiation is a potential hazard should have at least one of these Gilbert Geiger Counters. Don't let the low cost fool you: nuclear experts have pronounced it BETTER than Geiger Counters costing twice to three times as much! In addition to protection, Gilbert Geiger Counter offers opportunity to win \$35,000 Government bonus—the amount paid for Uranium Ore finds. Full details in "Prospecting for Uranium" book packed with Counter. Clicks sound with increasing intensity when radioactivity is detected; at same time neon light indicator flashes. Battery and Uranium ore source included. Geiger Counter measures 4½" square, 3" high. Packed 1 per carton. Shipping weight 3 lbs.

\$35,000 REWARD!

A real promotional opportunity! New legislation has increased Government bonus from \$10,000 to \$35,000 for Uranium strikes. Full details packed with Atomic Energy Lab.

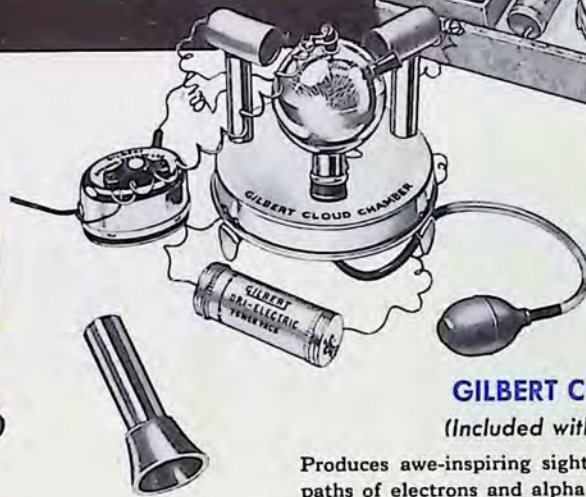

GILBERT CLOUD CHAMBER

(Included with Atomic Energy Lab)

Produces awe-inspiring sights! Enables you to actually SEE the paths of electrons and alpha particles traveling at speeds of more than 10,000 miles per SECOND! Electrons racing at fantastic velocities produce delicate, intricate paths of electrical condensation—beautiful to watch. Viewing Cloud Chamber action is closest man has come to watching the Atom! Assembly kit (Chamber can be put together in few minutes) includes Dri-Electric Power Pack, Deionizer, Compression Bulb, Glass Viewing Chamber, Tubing, power leads, Stand and Legs.

GILBERT ELECTROSCOPE

(Included with Atomic Energy Lab)

This instrument not only allows you to measure the radioactivity of ores (or of your radium dial wristwatch) but does the job as well as Electroscopes costing up to \$300.00! Easy to operate; just move ore within range of Ionization Chamber and Pointer (seen in eyepiece) moves along graduated scale. Highly accurate in determining quality of ore samples.

GILBERT SPINTHARISCOPE

(Included with Atomic Energy Lab)

Watch atomic disintegration of radioactive material—right before your eyes! Completely safe and harmless. Alpha particles streaking at 10,000 miles per SECOND smash into fluorescent screen and produce flashes of light. Lens in eyepiece enables you to watch this amazing sight in darkness.

All Toys in this catalog are products of
THE GILBERT HALL OF SCIENCE

NOTE: Because of emergency conditions beyond our control, The A. C. Gilbert Company reserves the right to change composition, materials, finishes or carton packing, without notice. We cannot guarantee that orders placed will be shipped 100%.

THE A. C. GILBERT COMPANY
ERECTOR SQUARE
NEW HAVEN 6, CONNECTICUT, U. S. A.