

# AMERICAN FLYER TRAINS

OFFICIAL TRAIN BOOK FROM

THE GILBERT HALL OF SCIENCE



FIRST SCALE MODEL HOTSHOTS  
THAT "CHOO-CHOO"  
- HEAR EM!

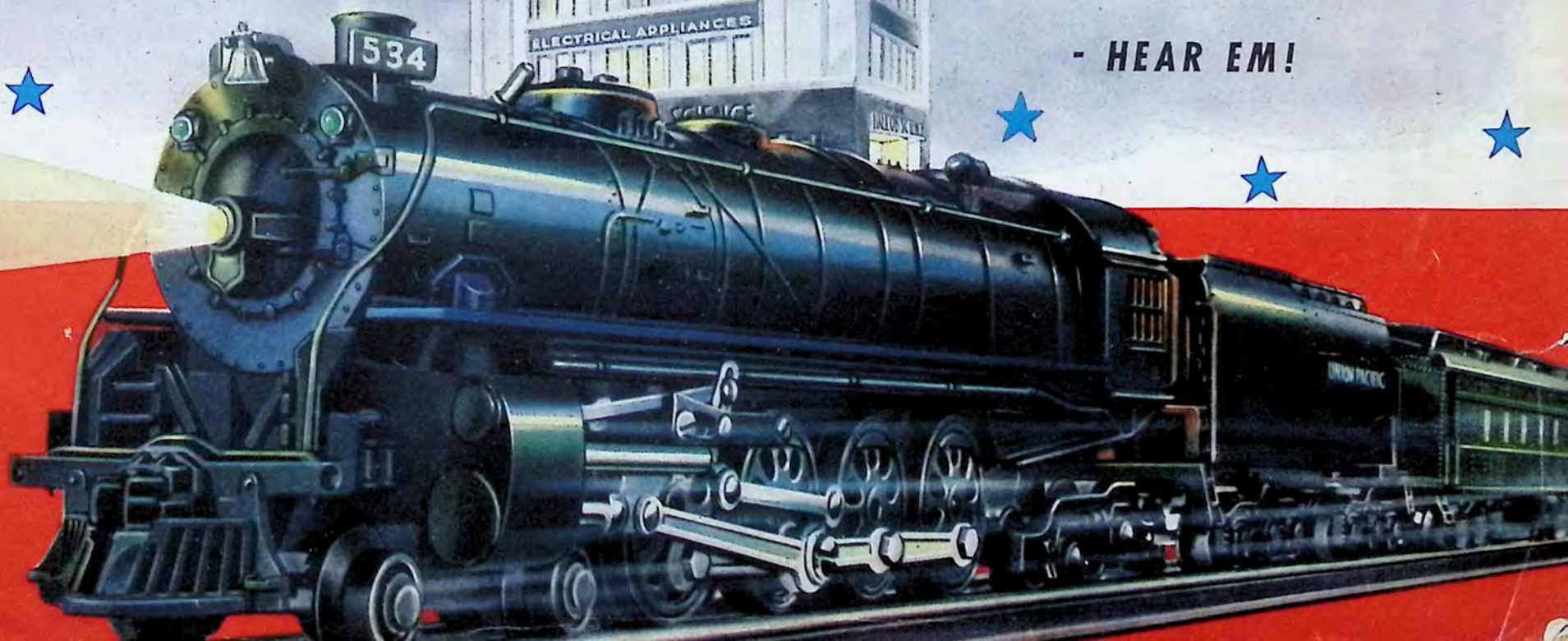



"Boys! The New American Flyer built-in "CHOO-CHOO" is the first and only device that brings to your ears the thrilling sounds of mighty mechanical power that you hear from a real train. Read all about it... then hear it at your nearest department or toy store."

*A.C. Gilbert* President  
The A. C. Gilbert Co. and  
Founder of the Gilbert Hall of Science

Can you imagine going to a circus and not hearing the band... seeing a ball player knock a home-run without hearing the crack of the bat... watching a football game at which there was no cheering? None of these events would seem real without the glorious, exciting sounds that go with them.

The same is true of railroading. Whenever you see a real locomotive-whether it is standing at a station or speeding through the countryside -there comes to your ears the constant chorus of its "choo-choos". Those "choo-choos" are just as vital a part of a real locomotive as its drive wheels, piston rods, headlight, etc.

In order to enjoy all the exciting drama of railroading, you naturally want a train that not only looks like



CHOO-CHOO  
CHOO-CHOO  
**LISTEN TO THAT  
"CHOO-CHOO"**



real but also *sounds* like real. And that is exactly the kind of train American Flyer engineers have now created for you - a train that actually choo-choos - that accurately reproduces the fiery, tempestuous rumbles and hisses of a giant locomotive under full steam.

The marvelous new American Flyer "Choo-Choo" is built right into your train and so distinct are its choo-choos they can be heard at distances of over 100 feet.

But the most wonderful feature of this amazing new American Flyer "Choo-Choo" is that it changes tone and tempo with every change in train speed - thus doing exactly what a real locomotive does.

Suppose your train is standing at a station. The choo-choos start the instant you turn on the electric current... slow, deep-throated, impatient choo-choos they are then... the sound of heaving horsepower eager to go.

Now nose your train out of the station. Instantly the chorus of choo-choos quicken their pace. Turn your throttle up another notch or two. Still faster come the sonorous snorts of those choo-choos.

Now give your train the highball signal as it storms over the rails at full speed, your choo-choos burst into a fast and furious cascade of sound - singing the magic, thrilling song of the rails with glorious realism.

Once you hear the new American Flyer "Choo-Choo", no electric train will seem complete without it. Listen to it today at your nearest department or toy store. Take Dad along... and he will be just as enthusiastic as you over your getting an American Flyer Train for Christmas.



**THE A. C. GILBERT COMPANY**  
New Haven, Conn., U. S. A.

Copyright 1941 By The A. C. Gilbert Co.  
New Haven, Conn., U.S.A.

# Every American Flyer Train is 3/16" Scale from Front End to Rear End

## Twice the Track - Twice the Fun

The fun of electric railroading goes up fast every time you increase the amount of track. Having a two-loop system, with double switches—and possibly sidings—is twice as much fun as having just one loop. Adding a third loop—and crossovers—makes operating your railroad system even more spectacular and exciting.

But perhaps you are thinking, or Dad or Mother will say, "We haven't enough floor space for all that."

An important advantage to American Flyer 3/16" scale models is that they operate on "O" gauge track of only 40" in diameter. Thus you can have multiple track layouts in extremely small space.



## WHY 3/16" SCALE MODELS ARE TOPS IN REALISM

"O" Gauge track is by far the most popular track width both with boys and hobbyists. It is the size you probably have or will get.

In order to have a realistic "O" gauge system, your locomotives and cars must not only be scale models, but in addition must be built to the scale that looks most realistic and operates in the most realistic way. That scale is 3/16"—which means that for every foot of actual train length, height and width, all American Flyer locomotives, tenders and cars are made 3/16 of an inch. Furthermore, American Flyer designers take these measurements from actual railroad blueprints to insure their being correct in every detail.

Extensive experiments conducted at the Gilbert Hall of Science prove that 3/16" scale is the ideal train scale for "O" gauge track. It looks most realistic, hugs the rails more realistically, and is the largest scale size that can be operated satisfactorily on "O" gauge track of 40" diameter.

C O M P A R E



## Why Waste Floor Space?

How important track diameter is in building realistic layouts in small space is graphically shown by the illustrations below. Both illustrations represent an area approximately 6 feet square. With 72" diameter track it is possible to have only one loop in this space. See illustration below. With American Flyer 40" diameter track, on the other hand, you can easily have two loops in a 6 foot square area. See illustration in lower left hand corner. If you have plenty of room, American Flyer track enables you to have twice as many loops, figure 8s, etc., as larger diameter track in the same space.

1 FOOT 2' 3' 4' 5' 6'

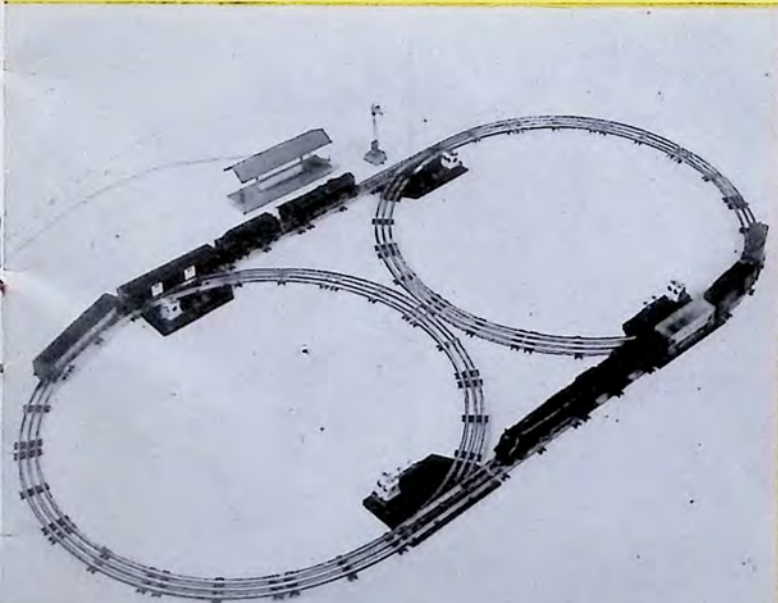

1 FOOT 2' 3' 4' 5' 6'

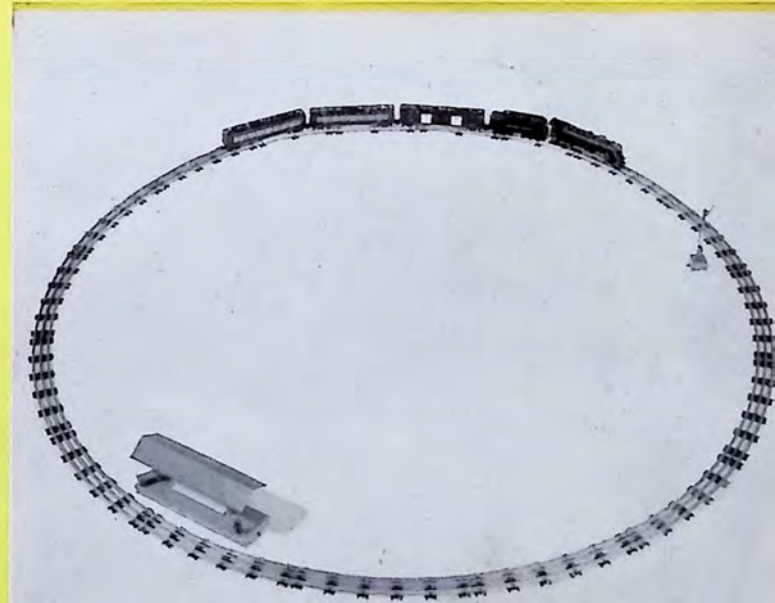

# EQUIPMENT that is tops in REALISM

• ALL BUILT TO SCALE - TRUE TO LIFE ACTION  
• OPERATE AUTOMATICALLY OR BY REMOTE CONTROL

"CHOO-CHOO"



### "CHOO-CHOO" TENDER

Built-in "choo-choo" reproduces realistic locomotive sound effects—synchronized to change tone and tempo with speed of train. *See Page 36*

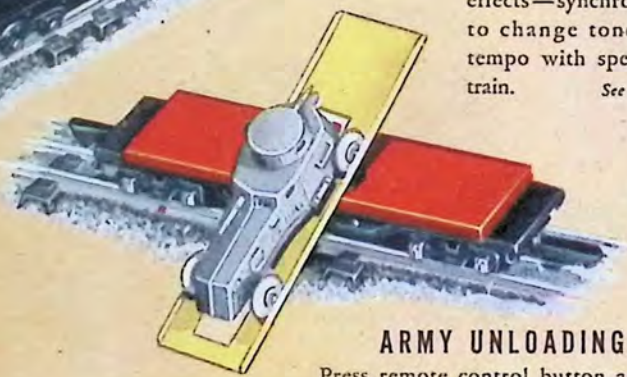

### ARMY UNLOADING CAR

Press remote control button and platform swivels and tilts, unloading armored truck. *See Page 37*



### WATER TANK

Water spout raises and lowers when you press remote control button. Aviation beacon on top. *See Page 40*



### SEMAPHORE

Arm shifts automatically. Shows red light to stop train—green to go. Permits two train operation on single track. *See Page 39*

### TRACK GANG SET

Men automatically stop work and flagman moves forward when train passes. Resume work when track is clear. *See Page 40*



### MAIL PICK-UP CAR

Grabs sack of mail while train is in motion, automatically tossing out another sack. Operated by remote control. *See Page 37*

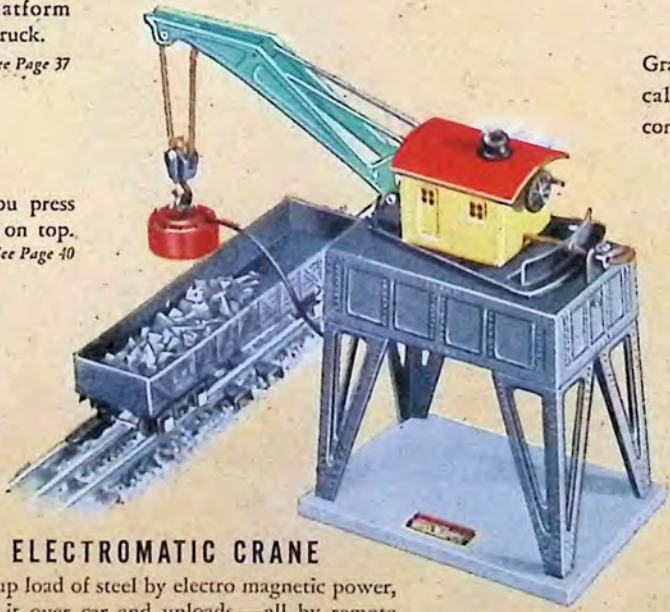

### ELECTROMATIC CRANE

Grabs up load of steel by electro magnetic power, swings it over car and unloads—all by remote control. *See Page 40*

### DUMP CAR

Side opens and dumps load of coal into bin when you press remote control button. *See Page 37*



# NOW! Every American Flyer Locomotive has Super-Power WORM DRIVE

Banishes JERKY  
"JACK RABBIT" PULL

Smooth PRECISION CONTROL  
AT SLOW OR HIGH SPEEDS

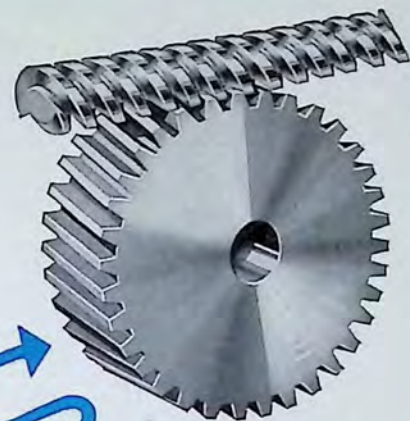
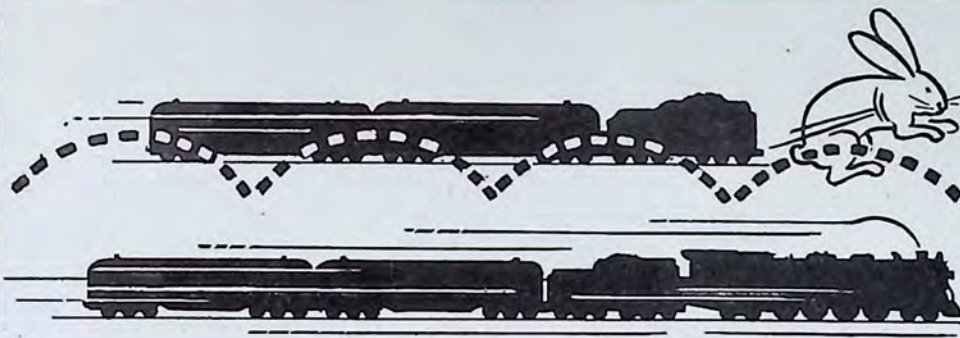

## Inside Information on Why American Flyer Locomotives Give Quieter Operation and More Accurate Control

One of the tests of an expert railroad engineer is whether he can stop and start his train with such smooth precision as not to jostle and jar passengers. Realistic operation of miniature train calls for similar accurate control.

With old-fashioned spur gear drives, it was virtually impossible to operate a train without jerking and bucking. And this might be so bad as to cause cars to jump the track.

Such troubles are a thing of the past with the new American Flyer locomotives—because every one has a modern, precision-made worm gear drive.

By giving a greater reduction in speed (18:1) worm gear drive increases the turning torque correspondingly, making possible slower, smoother, more realistic starting. Thus you can nose your train out of stations as a true engineer would do it.

In addition, worm gear drive enables you to maintain slow speeds without danger of stalling—and gives you the steady surge of power you need for high speeds. Speeds of 120 scale miles per hour are easily possible with American Flyer worm drive locomotives. And at all speeds worm drive is amazingly quiet.

Another reason for the superiority of American Flyer worm drive locomotives is that all parts are built to rigid specifications. For example, the gears are not stamped or die cast but machine cut to high precision standards.

- (A) Molded bakelite brush block.
- (B) Machine wound enamel wire field coil.
- (C) Oil impregnated bronze armature bearings.
- (D) Steel armature shaft ground to size. Worm cut directly into armature shaft.
- (E) Steel worm gear cut on American Flyer's own hobbing machines.
- (F) Locking lever to maintain operation in any desired direction.
- (G) Electro magnet which operates reverse switch.
- (H) Phosphor bronze spring contacts on reverse switch.
- (I) Reverse switch segments molded into drum with integral ratchet.
- (J) Light from readily removable headlight lamp conducted to proper location in boiler front by Lucite lens.
- (K) Drive wheels driven on knurled ends of steel axle.
- (L) Bronze bearings for driver axles.

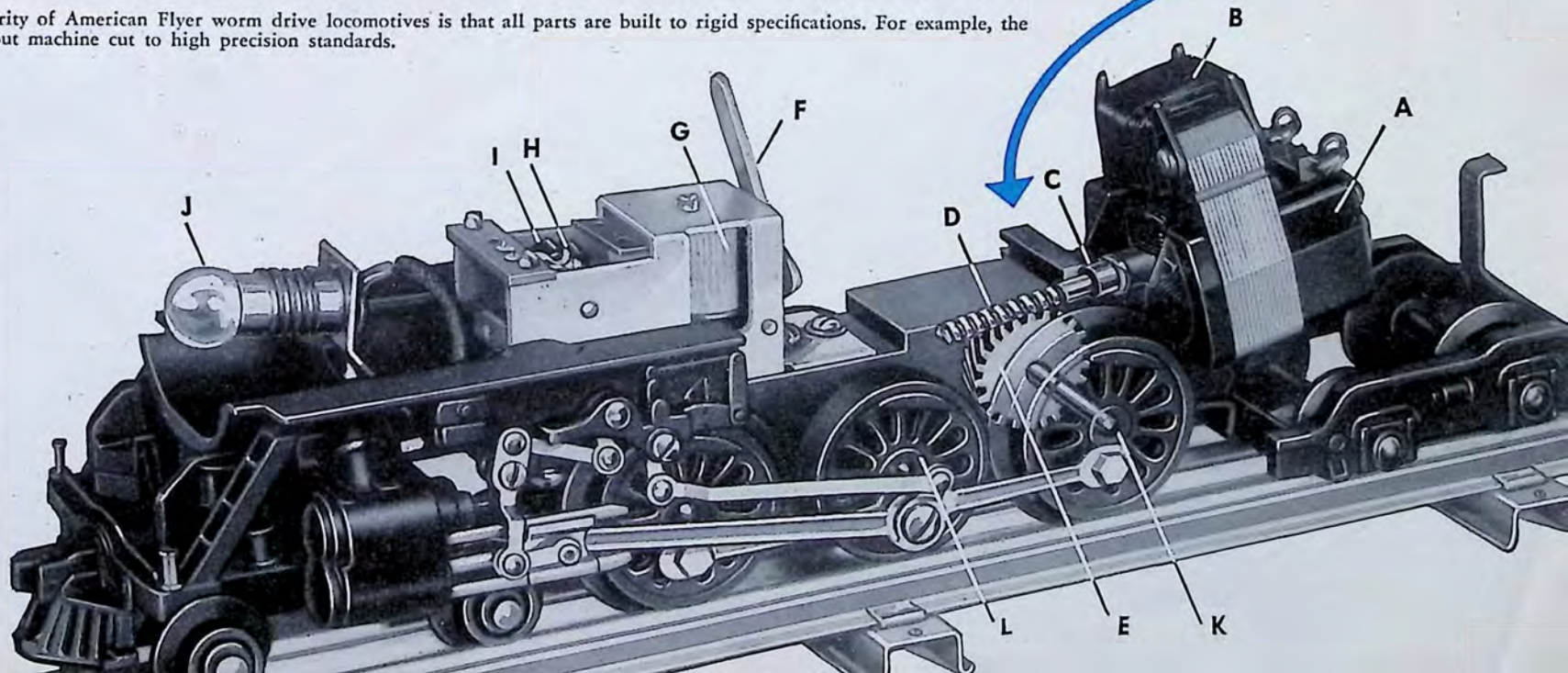

## KIT FOR BUILDING No. 559 PENNSYLVANIA LOCOMOTIVE AND No. 558 TENDER

Contains all necessary parts for quickly and easily assembling this famous 4-6-2 Pennsylvania K-5 locomotive and tender illustrated below. Armature, field, gears and drive wheels assembled to engine frame. Has worm drive, directional remote control unit and new positive action coupler on tender. Operates on A.C. only.

**K-559 LOCOMOTIVE AND TENDER KIT—\$12.50**



There's a new thrill to electric railroading when you build a giant locomotive and tender yourself. You fit the powerful motor with drive wheels attached under the long gleaming boiler—assemble the piston rods, steam chest, pilot and other fascinating parts—then paint it and attach the decals. It's amazingly easy with American Flyer Build-'em yourself kits which contain all the necessary parts correctly machined, drilled and tapped. All machine assemblies are completed. Paints, brush, decals and full instructions are all included. No special tools are required to do an expert job.

They will be the pride of your railroad line—these American Flyer Scale Models that you build yourself. They're realistic . . . they'll hustle over the rails like a real mainliner. Your friends will be amazed to learn that you built these authentic models yourself.

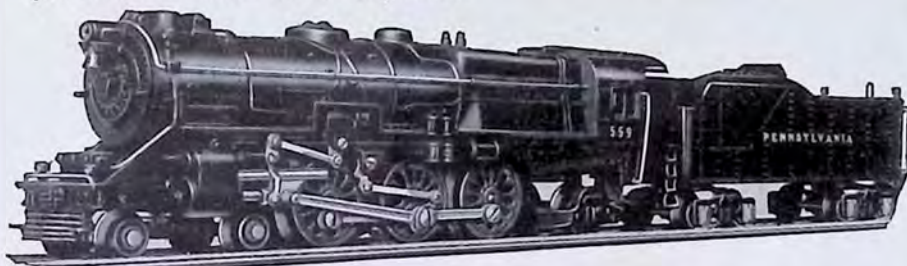

# BUILD YOUR OWN . . . . . SCALE MODEL HOTSHOTS

## KIT FOR BUILDING No. 531 N. Y. C. LOCOMOTIVE AND No. 563 TENDER

LOCOMOTIVES  
TENDERS  
AND CARS  
YOU  
CAN BUILD  
YOURSELF



3/16" SCALE FOR  
"O" GAUGE TRACK  
40" DIAMETER  
OR MORE  
ALL DIE CAST  
DIRECTIONAL  
REMOTE  
CONTROL

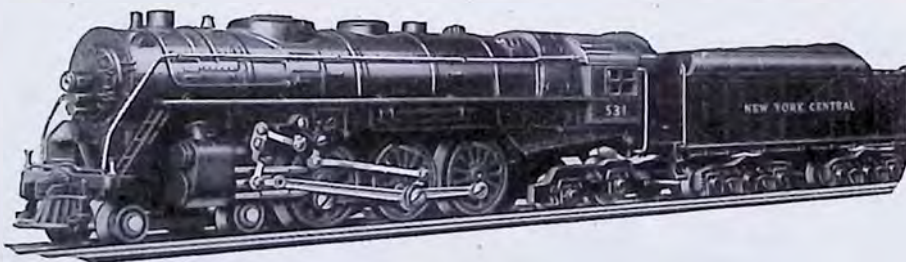

Easy-to-follow instructions help you assemble this powerful 4-6-4 type N. Y. C. Hudson locomotive and Tender. Armature, field, gears and drive wheels assembled to engine frame. Has worm drive, directional remote control unit and new positive action coupler on tender. Operates on A.C. only.

**K-531 LOCOMOTIVE AND  
TENDER KIT . . \$17.50**



## KIT FOR BUILDING No. 534 UNION PACIFIC LOCOMOTIVE AND No. 567 TENDER



You can easily and quickly assemble this big super power 4-8-4 Union Pacific Locomotive and tender. Armature, field, gears and drive wheels assembled to engine frame. Has worm drive, directional remote control unit and new positive action coupler on tender. Operates on A.C. only.

**K-534 LOCOMOTIVE AND  
TENDER KIT . . \$22.50**





K-521 BAGGAGE AND CLUB CAR KIT . . . . . \$4.50

Contains everything you need to build a beautiful authentically scaled Baggage and Club Car. Genuine die-cast car measuring 12" long. Has two 6 wheel trucks and interior electric light. Sliding door into baggage compartment and hinged door into vestibule. Green enamel paint included for a lustrous finish.

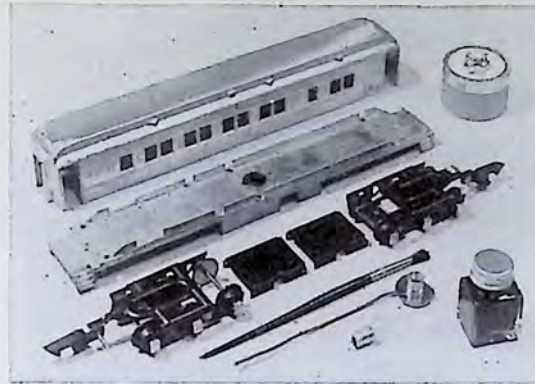

K-524 PULLMAN CAR KIT . . . . . \$4.50

You can assemble a magnificent 12" die-cast Pullman with this easy-to-build set of parts. Electric light for the interior, double trucks, 12 wheels and simulated glass windows with curtain trim are all included in this exceptional kit. Green enamel paint for smart appearing finish.



K-508 HOPPER CAR KIT . . . \$3.00

When you assemble this 6 1/2" die-cast car you have a job so true to life that even the rivet heads show. All wheels, journal boxes and appointments are authentically scaled. Kit complete with automatic couplers.



K-510 CATTLE CAR KIT . . . \$3.00

Builds 7 1/2" die-cast model of cars used to transport cattle to the country's largest stock yards. Building your own rolling stock the new American Flyer way adds new fun to electric railroading.

## It's a cinch with AMERICAN FLYER "Build-em-Yourself" KITS

K-512 TANK CAR KIT . . . \$3.00

Contains complete parts, equipment and instructions for assembling and finishing Texaco Tank Car. Rails, ladders, simulated filler cap, two 4 wheel trucks, and automatic couplers for this 7 1/2" die-cast realistic car.

K-504 GONDOLA CAR KIT . \$3.00

Car is die-cast and measures 7 1/2". Kit has all parts and material for complete finishing. Automatic couplers, two 4 wheel trucks, nickel journal boxes and authentic appointments all ready for quick assembly.

K-514 WRECKER CAR KIT . \$4.00

"Big Hook" is what railroad men call a wrecker car. With this kit you can build a 7 1/2" die-cast Wrecker with hoisting equipment. Cab and boom turns on swivel base. Boom raises and lowers.

K-506 BOX CAR KIT . . . \$3.00

Assembling this die-cast 7 1/2" Box Car will be real fun. Kit contains everything you'll need for a finished job including wheels, fittings, automatic couplers, paints and brush.

K-516 CABOOSE KIT . . . \$3.50

Complete parts and equipment for assembling and finishing die-cast electrically illuminated caboose, 6" long. Two 4 wheel trucks, automatic couplers, authentic fittings, paint and brush included in this set.

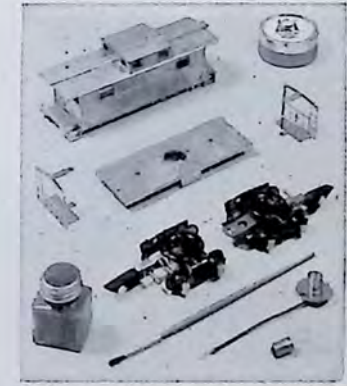

GILBERT

## AMERICAN FLYER TRAINS

FOR "O" GAUGE TRACK



EVERY LOCOMOTIVE AND EVERY CAR BUILT TO  
3/16" SCALE FROM RAILROAD BLUEPRINTS



EVERY TRAIN AN AUTHENTIC REPLICA OF ITS PROTOTYPE



EVERY LOCOMOTIVE WITH QUIET-RUNNING,  
SMOOTH-PULLING WORM GEAR DRIVE



FIRST TRAINS THAT "CHOO-CHOO"—REPRODUCING  
STIRRING SOUND EFFECTS OF REAL TRAINS IN ACTION

Owing to emergency conditions beyond our control  
The A. C. Gilbert Co. reserves the right to change  
prices, contents or materials used without notice.

### 33 SPECTACULAR 3/16" SCALE MODEL TRAINS FOR "O" GAUGE TRACK EACH ONE AMERICA'S PACEMAKER IN ITS PRICE CLASS

American Flyer Trains are the first choice among boys and hobbyists who demand the utmost in realism. Because American Flyer Trains are literally crammed with exclusive and expensive features—features found in no other trains—features that multiply by many times the exciting fun of miniature railroading.

Today American Flyer Trains are more gloriously realistic than ever before. To their achievements of the past, American Flyer engineers and technical experts of the Gilbert Hall of Science have now added dazzling new features. There are important new developments in sound effects—in locomotives—in cars—and in equipment—all of which make American Flyers the most sensationally realistic trains you can own.

You'll find full descriptions of every train with its exciting features and each piece of superb equipment on the following pages. Study every picture—read every word.

Here are a few American Flyer high points to keep in mind:

All trains operate by remote control or directional remote control. You don't have to touch your train to stop and start, change direction or regulate speed.

All trains are 3/16" scale models from end to end, and are accurate replicas of real trains. Every set has an authentic tender—correctly designed for the locomotive it goes with.

Perfected super-power worm drive is standard equipment in every locomotive—and every locomotive has Lucite electric headlight.

There are 140" or more of running track with every "O" gauge set.

All American Flyer "O" Gauge track is 40" diameter, is interchangeable and of the same high quality construction. Thus any two or more sets can be combined to make a larger system—and when you buy extra track, you are sure it will fit.

All trains have automatic couplers and electric uncoupling operated by remote push button control.

Read the full description of each thrilling set. The more you study them—compare them with ordinary trains—and see how much extra value you get for your money, the more you will realize why experts on miniature railroading are picking American Flyer.

# SEE HOW LITTLE IT COSTS TO GET A REALISTIC 3/16" SCALE MODEL

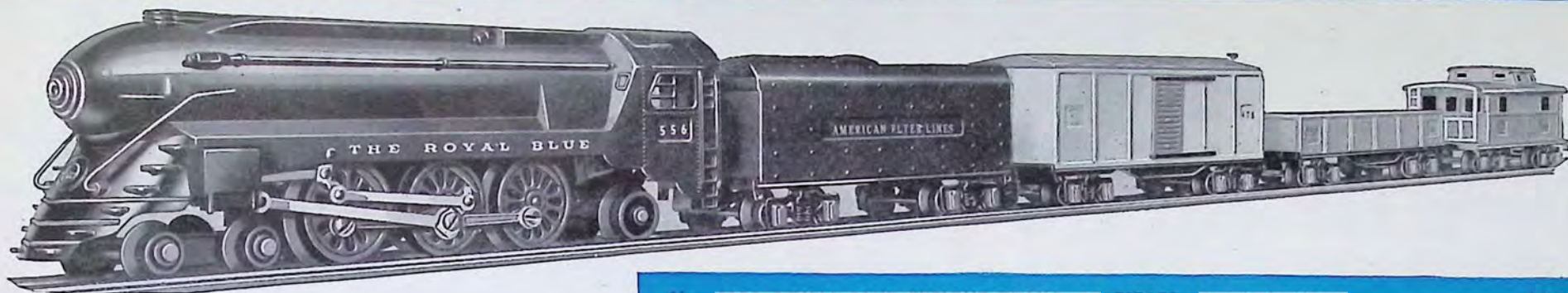

**No. 4101 ROYAL BLUE FREIGHT TRAIN—21 PIECES—41 1/2" LONG . . . . . \$8.50**

Here's an inexpensive train with exclusive features. Locomotive is die-cast, has worm drive and is operated by remote control. Every car and rear of tender has automatic couplers that work anywhere; can be uncoupled electrically by remote control. Operates on "O" gauge track of 40" diameter or more. Locomotive and tender finished in Royal Blue electrically baked enamel. Every car has double trucks, 8 wheels, nickel journal boxes and vivid baked enamel finish. Box car has sliding doors. Fourteen sections of track make 140" oval. 50 or 75 Watt Transformer recommended.

Set consists of: Locomotive No. 556; Tender 555, 17 3/4" long; 478 Box, 7 5/8"; 476 Gondola, 7 5/8"; 484 Caboose, 6 1/2". Track: 12 No. 680 curved, 1 No. 681 straight and 1 No. 675 straight with built-in uncoupling device. 1 No. 450 Track Terminal. Cost of 21 pieces if purchased separately, \$18.80.

**No. 4101 TRAIN SET . . \$8.50**

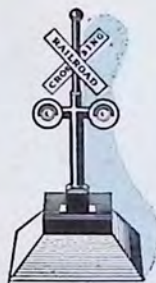

Automatic Blinker Signal with double bull's eye blinker adds further realism.

**ROYAL BLUE 4-6-2**

★ 3/16" Scale Model  
 ★ Steam Type—Torpedo Design  
 ★ Worm Drive  
 ★ Remote Control  
 ★ Automatic Coupling  
 ★ Electric Uncoupling



You operate all train movements by remote control.

**No. 4102 ROYAL BLUE PASSENGER TRAIN—21 PIECES—51 1/4" LONG . . . . . \$9.50**

You'll feel proud of every detail of this gleaming crack express. Locomotive is torpedo design of the 4-6-2 type. Six drive wheels with eccentric arm triple action piston rods, 4 wheel pony, 2 wheel booster trucks. Tender is bunker type with realistic imitation coal, ladder and 8 wheels. The three cars are each 10 3/4" long and match locomotive in color, all being finished in Royal Blue electrically baked enamel with white and nickel trim. Baggage car has sliding doors. Track equipment is same as for No. 4101 Train and makes oval 40" x 50". Thanks to its worm drive, train is remarkably quiet and can instantly be speeded up or slowed to a crawl without jumping or jerking. 50 or 75 Watt Transformer recommended.

Set consists of: Locomotive No. 556; Tender No. 555, 17 3/4" long; 1 494B Baggage, 10 1/4"; 2 495B Coaches, 10 3/4". Track: 12 No. 680 curved, 1 No. 681 straight and 1 No. 675 straight with built-in uncoupling device. 1 No. 450 Track Terminal. Cost of 21 pieces if purchased separately, \$21.05.

**No. 4102 TRAIN SET . . \$9.50**

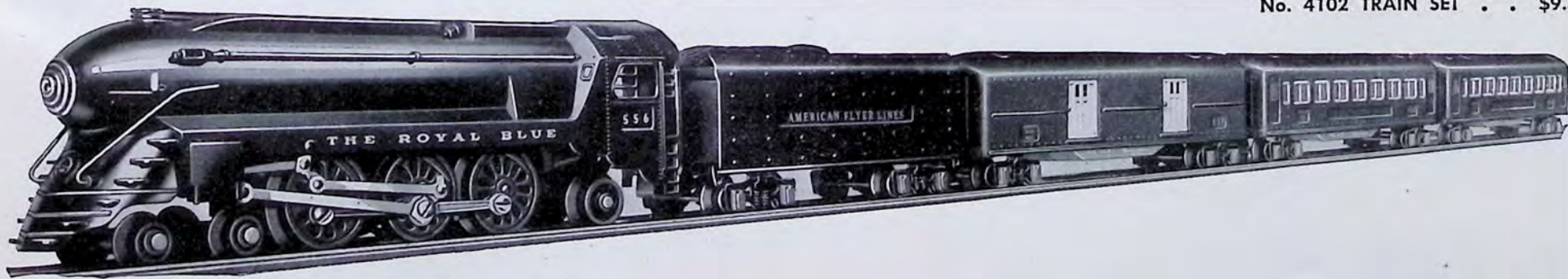

CRUSADER

4-4-2

- ★ 3/16" Scale Model
- ★ Atlantic Steam Type
- ★ Worm Drive
- ★ Remote Control
- ★ Automatic Coupling
- ★ Electric Uncoupling

ONLY AMERICAN FLYER  
OFFERS YOU - REALISTIC  
SOUND EFFECTS - FOR SO  
LITTLE MONEY



Why buy unscaled trains when 3/16"  
scale models cost no more?

B &amp; O

4-6-2

- ★ 3/16" Scale Model
- ★ Steam Type—Torpedo Design
- ★ Worm Drive
- ★ Remote Control
- ★ Automatic Coupling
- ★ Electric Uncoupling

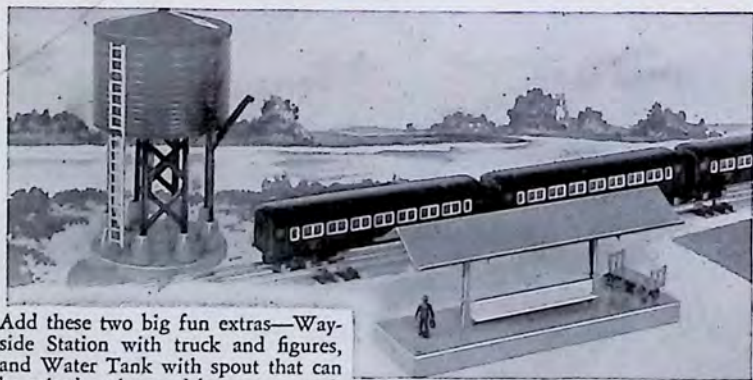

Add these two big fun extras—Way-  
side Station with truck and figures,  
and Water Tank with spout that can  
be raised or lowered by remote push  
button control.

No. 4103 CRUSADER FREIGHT TRAIN—21 PIECES—40" LONG . . . \$10.50

There are miles of thrills in operating this fast freight. The boiler front is removable, for ease in changing lamp bulb in headlight. Log car has six realistic logs and brake wheel. Box car has sliding doors, so you can really load it with freight. Both cars are 7 $\frac{7}{8}$ " long. The 6 $\frac{1}{2}$ " Caboose has cupola, end rails and ladders. All cars are vivid colored enamel electrically baked, and the realistic close couplers automatically couple on curves or straight-away. Uncoupling is done by remote control. Just push a button—and the uncoupling device—which is built in a special section of track—does the rest. Train operates on any "O" Gauge track of 40" diameter or more. Track furnished with set makes 140" oval. 50 or 75 Watt Transformer recommended.

Set consists of: Locomotive No. 565; Tender 564, 16" long; 482 Log, 7 $\frac{3}{8}$ "; 478 Box, 7 $\frac{5}{8}$ "; 484 Caboose, 6 $\frac{1}{2}$ ". Track: 12 No. 680 curved, 1 No. 681 straight and 1 No. 675 straight with built-in uncoupling device. 1 No. 450 Track Terminal. Cost of 21 pieces if purchased separately, \$20.80.

No. 4103 TRAIN SET . . \$10.50

No. 4104 CRUSADER PASSENGER TRAIN—21 PIECES—50" LONG . . . \$11.50

Imagine yourself the engineer of this sleek scale model train. The locomotive is finished in true locomotive black, cars in red electrically baked enamel with white and nickel trim. Turn on the power! Faster and faster . . . then to a crawl . . . then fast again . . . Reverse by remote control. How quickly and smoothly that engine responds to your touch! That's because it has a worm gear drive. There's a big satisfaction in knowing it's built true to scale, too. It looks right—hugs the tracks right as it speeds around curves. Locomotive and tender are 16" long. Cars are each 10 $\frac{3}{4}$ " long. Locomotive has ten wheels with eccentric arm double action piston rods. Tender has 8 wheels and is piled high with imitation coal. Baggage car has sliding doors. Track equipment is same as for No. 4103 set. 50 or 75 Watt Transformer recommended.

Set consists of: No. 565 Locomotive and No. 564 Tender, 16" long; 494R Baggage, 10 $\frac{3}{4}$ "; 2 495R Coaches, 10 $\frac{3}{4}$ ". Track: 12 No. 680 curved, 1 No. 681 straight and 1 No. 675 straight with built-in uncoupling device. 1 No. 450 Track Terminal. Cost of 21 pieces if purchased separately, \$23.05.

No. 4104 TRAIN SET . . \$11.50

No. 4105 B & O FREIGHT TRAIN WITH "CHOO-CHOO"  
21 PIECES—41 $\frac{1}{2}$ " LONG . . \$12.50

The sensational new "Choo-Choo" built into this spectacular streamliner brings to your ears the thrilling sound effects of a real train in action. The "Choo-Choo" is so distinct you can hear it over 100 feet away—and is so realistic that it automatically varies with every change in train speed. Think how Dad and your friends will gasp with wonder as you control its speed and chorus of "choo-choos" by transformer throttle . . . uncouple cars by electric remote control . . . couple them automatically anywhere on the track. What a colorful string of cars the big torpedo locomotive hauls! Tank car with ladders, hand rails and brake wheel. Box car with sliding doors. Illuminated caboose. Every car finished in vivid colored enamel. 14 sections of 10" track make 140" oval. 75 or 100 Watt Transformer recommended.

Set consists of: No. 556 Locomotive; No. 555C Tender, 17 $\frac{3}{4}$ "; 478 Box, 7 $\frac{5}{8}$ "; 480 Tank, 7 $\frac{5}{8}$ "; 484L Caboose, 6 $\frac{1}{2}$ ". Track: 12 No. 680 curved, 1 No. 681 straight and 1 No. 675 straight with built-in uncoupling device. 1 No. 450 Track Terminal. Cost of 21 pieces if purchased separately, \$22.55.

No. 4105 TRAIN SET . . \$12.50

No. 4106 B & O PASSENGER TRAIN WITH "WHISTLE"  
21 PIECES—51 $\frac{1}{4}$ " LONG . . \$13.50

With one hand on the throttle and the other on the whistle control, you will feel like a real engineer as you make this crack express pound the rails. You can blow long wailing blasts—quick sharp blasts . . . reverse . . . pick up speed, slow down . . . all by remote control. Take a good look at that locomotive. Including tender it is 17 $\frac{3}{4}$ " long, is die-cast, has Lucite electric headlight and six drive wheels with eccentric arm triple action piston rods. Tender is authentic B & O type with 8 wheels and big pile of imitation coal. Each car is 10 $\frac{3}{4}$ " long and finished in Royal Blue enamel to match locomotive. Both coaches are illuminated for spectacular night operation. Express car has built-in whistle. Track makes 40" x 50" oval. 75 or 100 Watt Transformer recommended.

Set consists of: No. 556 Locomotive; No. 555 Tender, 17 $\frac{3}{4}$ "; 1 490B Whistling Express Car, 10 $\frac{3}{4}$ "; 2 495BL Coaches, 10 $\frac{3}{4}$ ". Track: 12 No. 680 curved, 1 No. 681 straight and 1 No. 675 straight with built-in uncoupling device. 1 No. 450 Track Terminal. Cost of 21 pieces if purchased separately, \$23.75.

No. 4106 TRAIN SET . . \$13.50

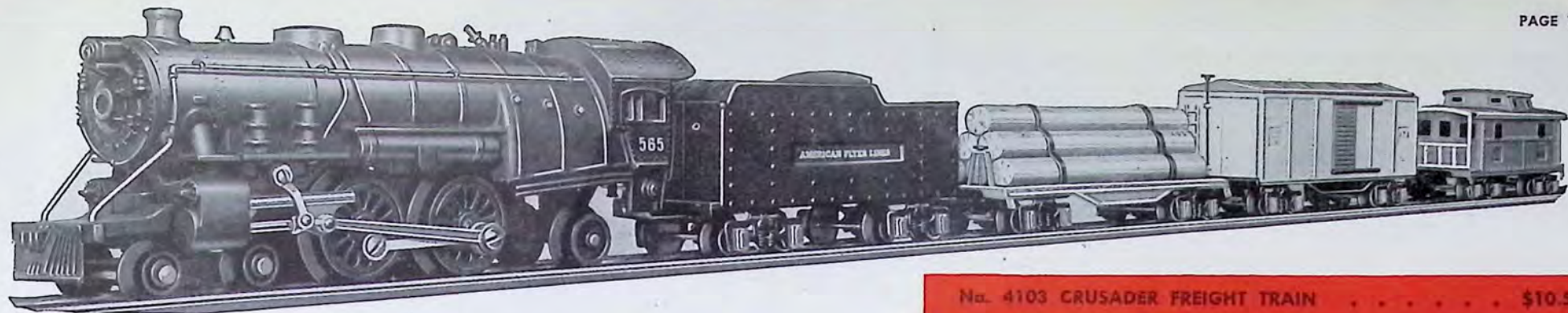

No. 4103 CRUSADER FREIGHT TRAIN . . . . . \$10.50

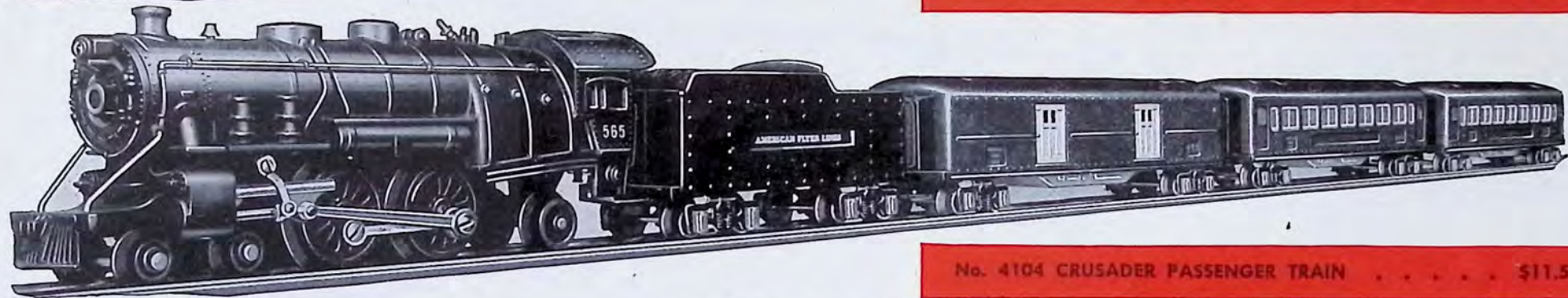

No. 4104 CRUSADER PASSENGER TRAIN . . . . . \$11.50

**"CHOO-CHOO"**



No. 4105 B & O FREIGHT TRAIN WITH "CHOO-CHOO" \$12.50

**"WHOO-WHOO"**

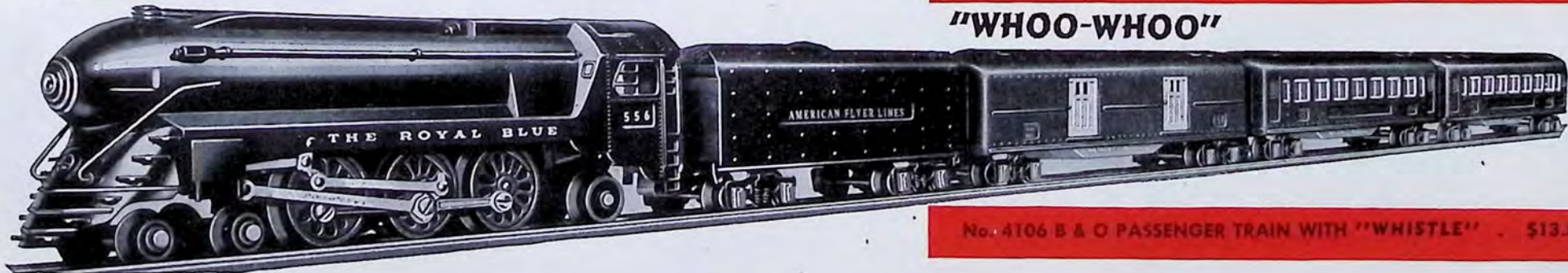

No. 4106 B & O PASSENGER TRAIN WITH "WHISTLE" . \$13.50

## BLUE BIRD

4-4-2

- ★ 3/16" Scale Model
- ★ Atlantic Steam Type
- ★ Worm Drive
- ★ Remote Control
- ★ Automatic Coupling
- ★ Electric Uncoupling

# MAMMOTH - WORM DRIVE SCALE MODELS THAT SURGE OVER THE RAILS WITH BREATH-TAKING SPEED . . .



Only worm drive gives quiet  
smooth pulling power.

## RED ARROW

4-6-2

- ★ 3/16" Scale Model
- ★ Pacific Steam Type
- ★ Worm Drive
- ★ Remote Control
- ★ Automatic Coupling
- ★ Electric Uncoupling



Add this scale model girder  
bridge—and hear trains rumble  
over it.

Watch trains stop and go as  
this semaphore shifts from red  
to green.



## No. 4107 BLUE BIRD FREIGHT TRAIN WITH "CHOO-CHOO" 21 PIECES—40" LONG . . . \$13.95

Highball this fast freight at top speed and a throbbing chorus of "choo-choos" will greet your ears . . . bring it to a stop and its "choo-choos" become the slow deep breathing of impatient power. Not only does the new American Flyer "Choo-Choo" sound just like real but it changes tone and tempo with every change in train speed. Another fun feature of this train is its hopper car with manual control lever for dumping. Hopper car and caboose are each 6½" long and the Tank car is 7⅞" long. All are finished in brilliant colored enamel electrically baked. Atlantic design locomotive is die-cast with removable boiler front. Track makes 140" oval. 75 or 100 Watt Transformer recommended.

Set consists of: No. 565 Locomotive; 564C Tender, 16" long; 486 Hopper, 6½"; 480 Tank, 7⅞"; 484 Caboose, 6½". Track: 12 No. 680 curved, 1 No. 681 straight and 1 No. 675 straight with built-in uncoupling device. 1 No. 450 Track Terminal. Cost of 21 pieces if purchased separately \$24.30.

No. 4107 TRAIN SET . . . \$13.95

## No. 4108 BLUE BIRD PASSENGER TRAIN WITH "WHISTLE" 21 PIECES—50" LONG . . . \$14.95

It's a Mainliner in looks—and a Mainliner in the way it whistles. The whistle is built right in the train and operates by remote control push button. That means you can blow it anywhere, anytime—long or short blasts and all code signals. The die-cast locomotive has ten wheels with four drive wheels and realistic eccentric arm double action piston rods, electric headlight in removable boiler front. Locomotive, tender and all cars are built to 3/16" scale from railroad blueprints. Brilliant blue enamel with white and nickel trim gives these 10¾" cars a pleasing appearance as they flash around the track. Coupling is close type, automatic on every car. Cars uncoupled by electric remote control. 75 or 100 Watt Transformer recommended.

Set consists of: No. 565 Locomotive; 564 Tender, 16" long; 490B Whistling Express Car, 10¾"; 2 495B Coaches, 10¾". Track: 12 No. 680 curved, 1 No. 681 straight and 1 No. 675 straight with built-in uncoupling device. 1 No. 450 Track Terminal. Cost of 21 pieces if purchased separately, \$25.25.

No. 4108 TRAIN SET . . . \$14.95

## No. 4109 RED ARROW FREIGHT TRAIN—22 PIECES—50" LONG . . . \$15.50

Like all American Flyer Trains, this Red Arrow freight is a 3/16" scale model replica of a real train. Its six heavy drive wheels typify super power on the main line of the Pennsylvania and give plenty of traction for its load of four gleaming cars. Electric headlight is mounted behind removable boiler front for ease of changing. Jeweled markers and eccentric arm triple action piston rods, side rods and connecting rods give the engine a flashing beauty as it storms down the main iron. The "Army Searchlight Car" throws a long beam, tilts to any angle and turns on swivel base. Floodlight, Tank and Gondola Cars are each 7⅞" long. Caboose is 6½" long. All cars in vivid colored enamel. 75 or 100 Watt Transformer recommended.

Set consists of: No. 561 Locomotive; 558 Tender, 17¾" long; 488 Floodlight, 7⅞"; 476 Gondola, 7⅞"; 480 Tank, 7⅞"; 484L Caboose, 6½". Track: 12 No. 680 Curved, 1 No. 681 straight and 1 No. 675 straight with built-in uncoupling device. 1 No. 450 Track Terminal. Cost of 22 pieces if purchased separately, \$27.05.

No. 4109 TRAIN SET . . . \$15.50

## No. 4110 RED ARROW PASSENGER TRAIN—21 PIECES—51½" LONG . . . \$15.50

Picture a string of three flashing red cars powered by a giant, smooth-pulling, worm drive locomotive. Here is a train that will make you the envy of all your friends. You can uncouple cars by remote control while the train is in motion. You can couple them anywhere. Couplers lock together on contact. Track equipment makes 140" oval. All cars are 10¾" long, have red electrically baked enamel finish and white and nickel trim. Baggage car has sliding doors. Coaches are electrically illuminated. Length, height and width of cars and locomotive are in correct proportions, being built to 3/16" scale from actual railroad blueprints. 75 or 100 Watt Transformer recommended.

Set consists of: No. 561 Locomotive; 558 Tender, 17¾" long; 494R Baggage, 10¾"; 2 495RL Coaches, 10¾" long. Track: 12 No. 680 curved, 1 No. 681 straight and 1 No. 675 straight with built-in uncoupling device. 1 No. 450 Track Terminal. Cost of 21 pieces if purchased separately, \$26.55.

No. 4110 TRAIN SET . . . \$15.50

**"CHOO-CHOO"**



No. 4107 BLUE BIRD FREIGHT TRAIN WITH "CHOO-CHOO" . . . \$13.95

**"WHOO-WHOO"**

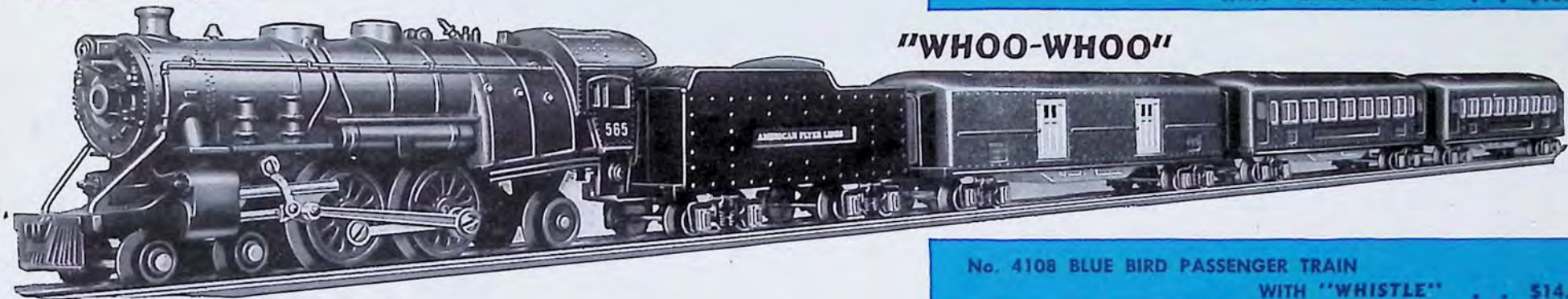

No. 4108 BLUE BIRD PASSENGER TRAIN WITH "WHISTLE" . . . \$14.95

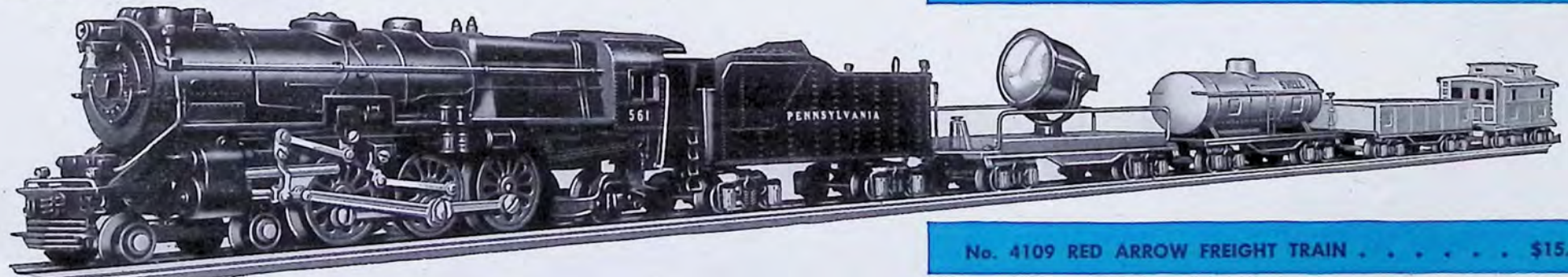

No. 4109 RED ARROW FREIGHT TRAIN . . . \$15.50

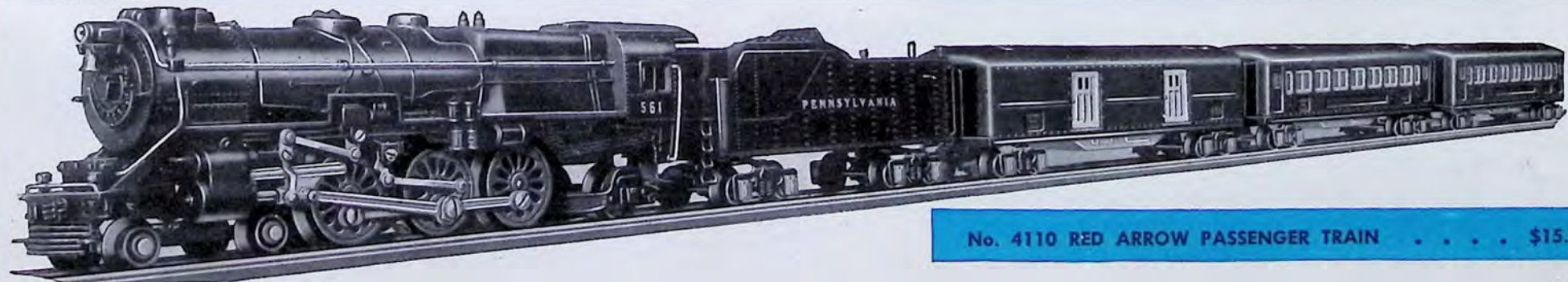

No. 4110 RED ARROW PASSENGER TRAIN . . . \$15.50

Hear this Black Diamond "CHOO CHOO" as it Highballs Heavy Loads



"CHOO-CHOO"

No. 4111 BLACK DIAMOND FREIGHT TRAIN WITH "CHOO-CHOO"  
22 PIECES—48 1/4" LONG . . \$17.50

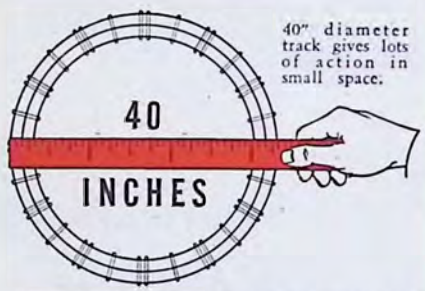

40" diameter track gives lots of action in small space.

- BLACK DIAMOND 4-4-2**
- ★ 3/16" Scale Model
  - ★ Atlantic Steam Type
  - ★ Worm Drive
  - ★ Remote Control
  - ★ Automatic Coupling
  - ★ Electric Uncoupling

Every American Flyer Train Set has 140" or more of running track.



Add this Tool Shed with sliding door to your line.

With this magnificent main line freight come two of the most exciting features ever added to miniature railroading. First, the built-in "Choo-Choo" producing the fascinating sound effects of a real locomotive. Second, the Armored Army Truck on special automatic unloading car. Just press a remote control button and platform swivels and tilts, shooting armored truck down incline. Box car with sliding doors, log car with six realistic logs and caboose are all finished in brilliant baked enamel. 14 sections of track makes 140" oval. All cars with automatic couplers. Lucite electric headlight on locomotive in removable boiler front. Caboose has electric light. 75 or 100 Watt Transformer recommended.

Set consists of: No. 565 Locomotive, 16" long; 472 Army Unloading, 7 3/8"; 478 Box, 7 3/8"; 482 Log, 7 5/8"; 484L Caboose, 6 1/2". Track: 12 No. 680 curved, 1 No. 675 straight with built-in uncoupling device; 1 No. 683 Unloading Track Set for 472 Unloading Car. Cost of 22 pieces if purchased separately, \$28.30.

No. 4111 TRAIN SET . . \$17.50

No. 4112 BLACK DIAMOND PASSENGER TRAIN WITH "CHOO-CHOO"  
21 PIECES—50" LONG . . \$17.50

Glorious to see—glorious to hear—and glorious to run! This fast mail is 3/16" scale model from end to end—"choo-choos" while running or standing still and has automatic mail car that grabs up sack of mail and tosses out another sack from the car. You direct the action by remote push button control. Die-cast locomotive has four mighty drive wheels with eccentric arm double action piston rods. 8 wheel tender is piled high with imitation coal. The 10 3/4" long green enamel coaches have electric lights and automatic couplers. 75 or 100 Watt Transformer recommended.

Set consists of: No. 565 Locomotive; 564C Tender, 16" long; 492G Automatic Mail Pick-up Car, 10 3/4"; 2 495GL Coaches, 10 3/4". Track: 12 No. 680 curved, 1 No. 675 straight with built-in uncoupling device; 1 No. 684 straight Mail Track Set for Mail Pick-up Car. Cost of 21 pieces if purchased separately, \$28.05.

No. 4112 TRAIN SET . . \$17.50

"CHOO-CHOO"



# 8 DRIVE WHEEL SWITCHER $\frac{3}{16}$ " Scale Model of Railroads Busiest Locomotive

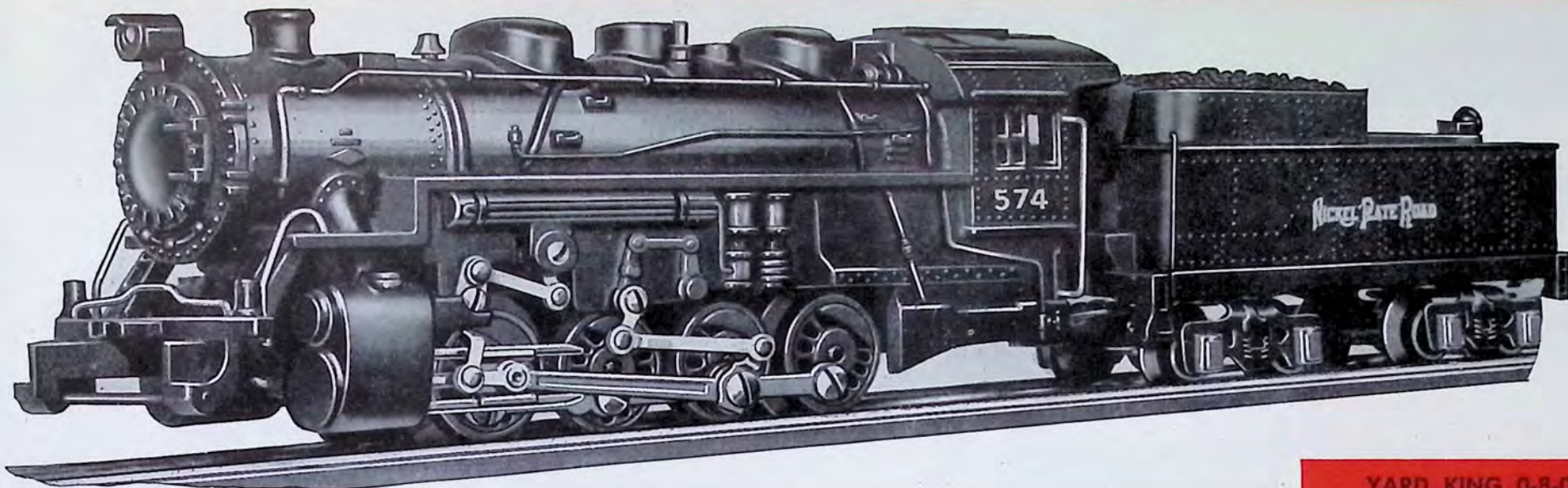

## No. 4113 YARD KING SWITCHER—22 PIECES— $46\frac{3}{4}$ " LONG . \$18.50

Real railroading excitement takes place in the busy classification yards where cars are switched from track to track to make up trains. That's why this powerful 8 drive wheel die-cast "yard goat" sets a new high for thrilling fun. Four fascinating cars: Flat Car with bridge girder; tank car with ladders and hand rails; box car with sliding doors; illuminated caboose. All in vivid colored enamel. Locomotive has smooth-pulling, easy-to-control worm drive, Lucite electric headlight in removable boiler front, eccentric arm triple action piston rods, side rods and connecting rods. Tender is die-cast, coal type and has rear Lucite light. Automatic coupling on front of locomotive, tender and all cars. Electric uncoupling device built in section of track, remote push button control. Track makes 140" oval. 75 or 100 Watt Transformer recommended.

Set consists of: No. 574 Locomotive; 573 Tender,  $14\frac{3}{4}$ " long; 483 Girder,  $7\frac{5}{8}$ "; 480 Tank,  $7\frac{5}{8}$ "; 478 Box,  $7\frac{5}{8}$ "; 484L Caboose,  $6\frac{1}{2}$ ". Track: 12 No. 680 curved, 1 No. 681 straight and 1 No. 675 straight with built-in uncoupling device. 1 No. 450 Track Terminal. Cost of 22 pieces if purchased separately, \$29.05.

## No. 4113 TRAIN SET . . \$18.50



It's fun to uncouple cars by remote push button control.

A double value addition—station with crane that swivels, raises and lowers.

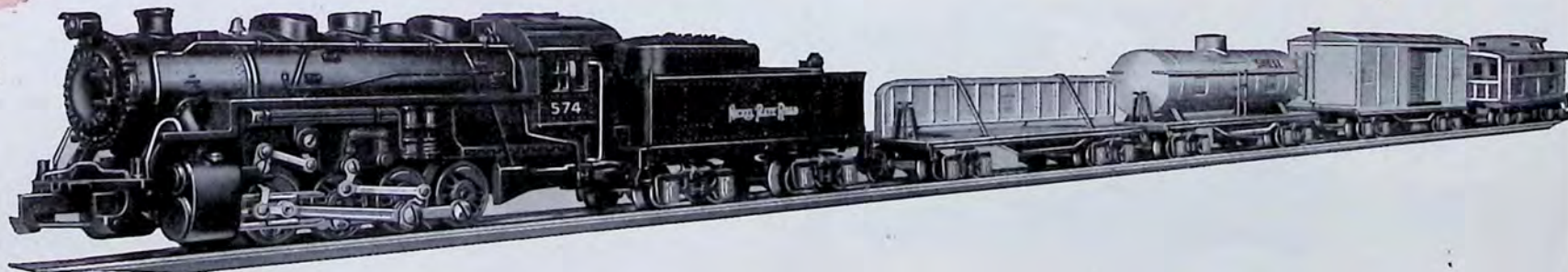

### YARD KING 0-8-0



- ★  $\frac{3}{16}$ " Scale Model
- ★ Steam Type
- ★ Worm Drive
- ★ Remote Control
- ★ Automatic Coupling
- ★ Electric Uncoupling

PENNSYLVANIA

4-6-2

- ★ 3/16" Scale Model
- ★ Pacific Steam Type
- ★ Worm Drive
- ★ Remote Control
- ★ Automatic Coupling
- ★ Electric Uncoupling

## CRACK HIGHLINERS THAT "CHOO-CHOO" AND HUSTLE OVER THE IRON WITH MIGHTY POWER

PACEMAKER

4-6-4

- ★ 3/16" Scale Model
- ★ Hudson Steam Type
- ★ Worm Drive
- ★ Remote Control
- ★ Automatic Coupling
- ★ Electric Uncoupling



Your "Choo-Choo" becomes doubly thrilling when you add this tunnel.

And see how this track gang stop and start work as trains whiz by.

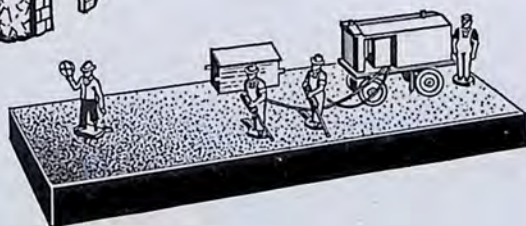

### No. 4114 PENNSYLVANIA FREIGHT TRAIN WITH "CHOO-CHOO" 22 PIECES—49" LONG . . . \$18.95

This authentic 3/16" scale model freight with "Choo-Choo" will thrill every Boy and Dad who owns it. Worm drive locomotive and tender are die-cast finished in locomotive black with jeweled markers. Every car is built for realistic railroading fun. Wrecker has cab and boom that turn on swivel base. Boom with hook raises and lowers. Log car has six realistic logs and brake wheel. Hopper has hand lever for dumping. Caboose is illuminated. All cars finished in vivid colored enamel electrically baked with nickel journal boxes. Cars automatically couple anywhere. Uncouple electrically by remote control push button. Fourteen sections of track make 140" oval. 100 or 150 Watt Transformer recommended.

Set consists of: No. 561 Locomotive; 558C Tender, 17 $\frac{3}{4}$ " long; 482 Log, 7 $\frac{5}{8}$ "; 481 Wrecker, 7 $\frac{5}{8}$ "; 486 Hopper, 6 $\frac{1}{2}$ "; 484L Caboose, 6 $\frac{1}{2}$ ". Track: 12 No. 680 curved, 1 No. 681 straight, 1 No. 675 straight with built-in uncoupling device. 1 No. 450 Track Terminal. Cost of 22 pieces if purchased separately, \$31.05.

No. 4114 TRAIN SET . . . \$18.95

### No. 4115 PENNSYLVANIA PASSENGER TRAIN WITH "CHOO-CHOO" 21 PIECES—51 $\frac{1}{2}$ " LONG . . . \$18.95

The six big drive wheels, the jeweled markers on locomotive and tender, the illuminated Pullman with imitation shades in windows all prove that this train is every inch a deluxe limited. The built-in "Choo-Choo" sings a song of surging power with such realism that you feel you are hearing a real train. Eccentric arm triple action piston rods, side rods and connecting rods glitter with action as they flash back and forth. Train fairly bristles with electric lights. Lucite headlight, lights in coach and Pullman. Operated at night with house lights off, it creates a lurid glare as it speeds over the gleaming rails. 100 or 150 Watt Transformer recommended.

Set consists of: No. 561 Locomotive; 558C Tender, 17 $\frac{3}{4}$ " long; 494T Baggage, 10 $\frac{3}{4}$ "; 495TL Coach, 10 $\frac{3}{4}$ "; 496TL Pullman, 10 $\frac{3}{4}$ ". Track: 12 No. 680 curved, 1 No. 681 straight, 1 No. 675 straight with built-in uncoupling device. 1 No. 450 Track Terminal. Cost of 21 pieces if purchased separately, \$30.30.

No. 4115 TRAIN SET . . . \$18.95

### No. 4116 PACEMAKER FREIGHT TRAIN—25 PIECES—58 $\frac{3}{4}$ " LONG . . . \$20.50

With such a variety of cars, automatic coupling and remote control electric uncoupler, this train gives you no end of fun switching cars around, loading and unloading freight, running your train at night with headlight and army searchlight piercing the darkness. Drawing a string of five freight cars, this giant worm drive locomotive has fourteen wheels, and, with tender, measures 19" in length. Entire train is built to 3/16" scale from railroad blueprints. Box car has sliding doors. Tank has ladders, hand rails and brake wheel. Floodlight has Army Searchlight that tilts on any angle and turns on swivel base. Hopper has hand lever for dumping. Caboose is illuminated. All cars finished in vivid enamel. Sixteen sections of track make 160" oval. 100 or 150 Watt Transformer recommended.

Set consists of: No. 570 Locomotive; 563 Tender, 19" long; 486 Hopper, 6 $\frac{1}{2}$ "; 478 Box, 7 $\frac{5}{8}$ "; 488 Floodlight, 7 $\frac{5}{8}$ "; 480 Tank, 7 $\frac{5}{8}$ "; 484L Caboose, 6 $\frac{1}{2}$ ". Track: 12 No. 680 curved, 3 No. 681 straight, 1 No. 675 straight with built-in uncoupling device. 1 No. 450 Track Terminal. Cost of 25 pieces if purchased separately, \$34.45.

No. 4116 TRAIN SET . . . \$20.50

### No. 4117 PACEMAKER PASSENGER TRAIN—24 PIECES—64 $\frac{1}{4}$ " LONG . . . \$20.50

There's an extra thrill to being the engineer of a great long train and that's the thrill you get with this famous Pacemaker. Its "string of varnish" consists of a Baggage car with sliding doors, illuminated Coach, illuminated Pullman with imitation window shades and illuminated Observation car with platform. All cars 10 $\frac{3}{4}$ " long, finished in red electrically baked enamel with white and nickel trim and have automatic couplers. Sixteen sections of track make 160" oval. Both locomotive and tender are die-cast, finished in true locomotive black and measure 19" in length. Six drive wheels with gleaming eccentric arm triple action piston rods, side rods and connecting rods. Electric headlight with removable boiler front. 100 or 150 Watt Transformer recommended.

Set consists of: No. 570 Locomotive; 563 Tender, 19" long; 494R Baggage, 10 $\frac{3}{4}$ "; 495RL Coach, 10 $\frac{3}{4}$ "; 496RL Pullman, 10 $\frac{3}{4}$ "; 497RL Observation, 10 $\frac{3}{4}$ ". Track: 12 No. 680 curved, 3 No. 681 straight, 1 No. 675 straight with built-in uncoupling device. 1 No. 450 Track Terminal. Cost of 24 pieces if purchased separately, \$35.70.

No. 4117 TRAIN SET . . . \$20.50

"CHOO-CHOO"



No. 4114 PENNSYLVANIA FREIGHT TRAIN WITH "CHOO-CHOO" . \$18.95

"CHOO-CHOO"



No. 4115 PENNSYLVANIA PASSENGER TRAIN WITH "CHOO-CHOO" . \$18.95

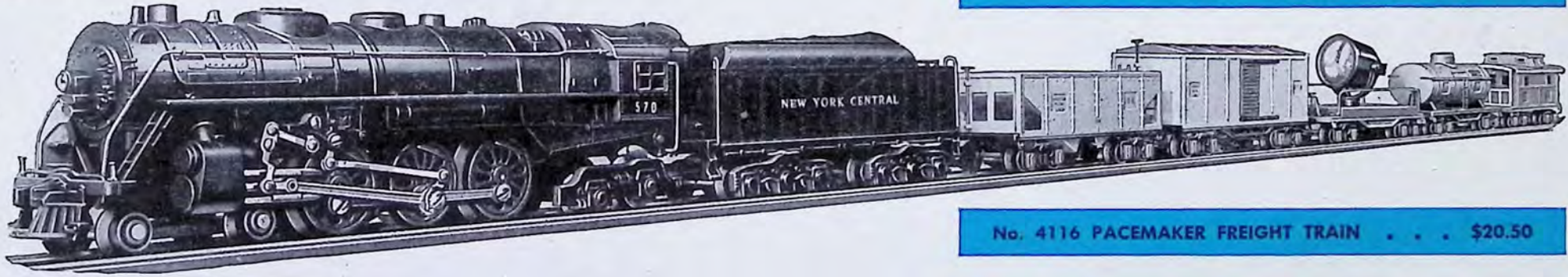

No. 4116 PACEMAKER FREIGHT TRAIN . . . \$20.50

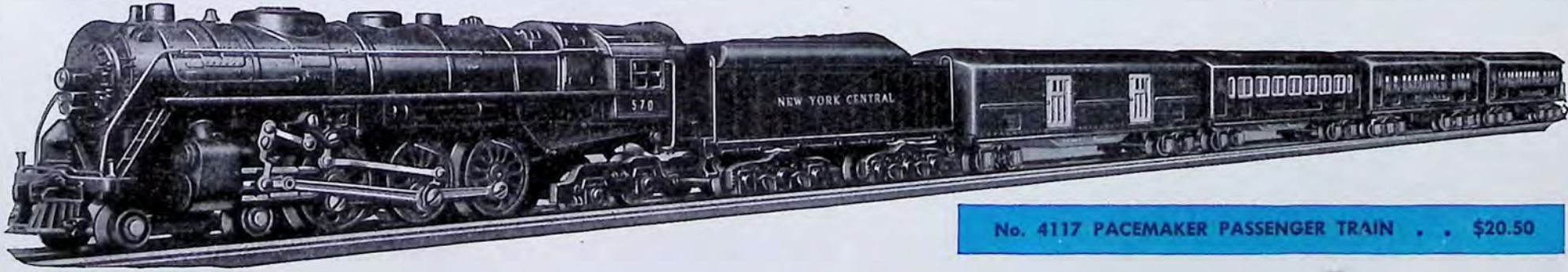

No. 4117 PACEMAKER PASSENGER TRAIN . . \$20.50

PRIDE OF THE PENNSYLVANIA Famous K-5 Locomotive Precision Built to 3/16" Scale

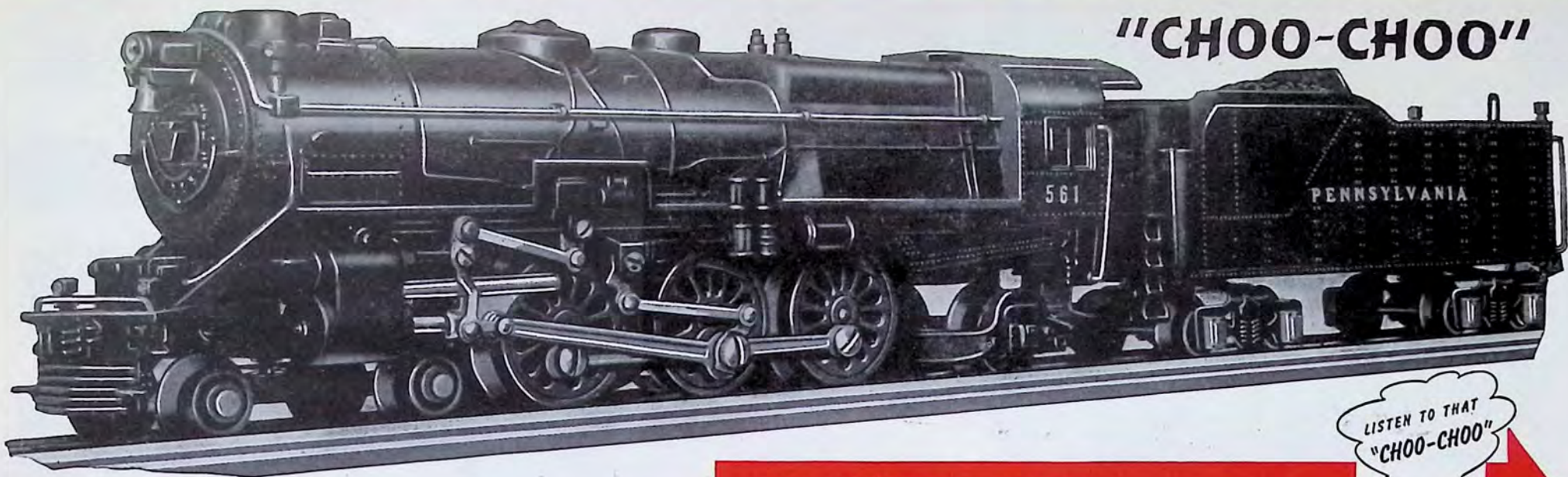

"CHOO-CHOO"

LISTEN TO THAT  
"CHOO-CHOO"



**BUILT IN "CHOO-CHOO"** Developed at the Gilbert Hall of Science, the new American Flyer "Choo-Choo" is the first and only device that successfully reproduces the thrabbing, surry "Choo-Choo" that you hear in a real locomotive.



IF IT ISN'T SCALE  
MODEL—IT ISN'T  
THE REAL THING

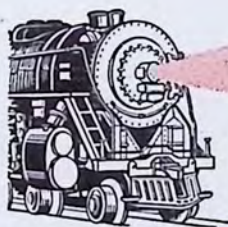

Lucite headlight  
casts long super-real-  
istic beam.

Hear it . . . own it!  
The talking railroad  
station that automati-  
cally stops trains—  
reproduces realistic  
sound effects — then  
starts train again.



PENNSYLVANIA 4-6-2

- ★ 3/16" Scale Model
- ★ Pacific Steam Type
- ★ Worm Drive
- ★ Remote Control
- ★ Automatic Coupling
- ★ Electric Uncoupling

**JUST LIKE REAL — IN SIGHT AND SOUND**

Pounding down the main line with everything wide open, this exciting 3/16" scale model Pennsylvania K-5 speeds over the rails to a chorus of "choo-choos" that echo and re-echo . . . just as the big Pennsylvania K-5s sing to their task over the Alleghenies.

Slow it to a crawl—and hear how the choo-choos keep pace in tone and tempo. Bring it to a stop—and the choo-choos become the panting growls of a mechanical monster eager to be on its way.

And what magic control over speed its worm drive gives you. Instantly, surely and smoothly it responds to each movement of your throttle.

Long beam Lucite headlight, in removable boiler front, jeweled markers, six powerful drive wheels with eccentric arm triple action piston rods and connecting rods, prove the precision engineering that go into this superb die cast 3/16" scale model locomotive and tender. The finish is gleaming locomotive black and tender is piled high with imitation coal.

LOCOMOTIVE No. 561 — TENDER No. 558C . \$16.00



**No. 4118 TRAIL BLAZER FREIGHT TRAIN WITH "CHOO-CHOO" — 27 PCS. — 58 1/2" LONG \$22.95**

Powered by the husky Pennsylvania K-5 locomotive described on opposite page, this big 5-car freight train picks up speed in a way to delight every highball artist. There are extra thrills, too, in bringing that armored car into action. Stop your train, press a remote control push button and its platform swings around, tilts and the armored truck runs off ready for action. All cars are built to 3/16" scale, have automatic couplers and are finished in vivid colored electrically baked enamel. Caboose is illuminated. Box car has sliding doors. Gondola has brake wheel. Tank has ladders, hand rails and brake wheel. Nickel journal boxes on all cars. Eighteen sections of track make 180" oval. 100 or 150 watt transformer recommended.

Set consists of: No. 561 Locomotive; 558C Tender, 17 3/4" long; 476 Gondola, 7 5/8"; 478 Box, 7 5/8"; 472 Army Unloading Car, 7 5/8"; 480 Tank, 7 5/8"; 484L Caboose, 6 1/2". Track: 12 No. 680 curved, 4 No. 681 straight, 1 No. 675 straight with built-in uncoupling device, 1 No. 683 straight Unloading Track Set for 472 Army Unloading Car. 1 No. 450 Track Terminal. Cost of 27 pieces if purchased separately, \$34.10.

**No. 4118 TRAIN SET . . \$22.95**

**No. 4119 TRAIL BLAZER PASSENGER TRAIN WITH "CHOO-CHOO" — 26 PCS. — 51 1/2" LONG \$22.95**

Authentic 3/16" scale model construction throughout, worm drive and realistic close coupling enable this sleek and gleaming passenger train to hug the rails even at top speeds. New automatic mail pick-up car discharges and gathers up mail while train is running, just like real trains. All action controlled by remote push button. Pullman and observation cars have six wheel trucks and imitation shades in windows. Electric light in Coach, Pullman and Observation. All cars finished in green enamel electrically baked. Automatic couplers and electric uncoupling. Eighteen sections of track make 180" oval. 100 or 150 watt transformer recommended.

Set consists of: No. 561 Locomotive; 558C Tender, 17 3/4" long; 492G Automatic Mail Pick-up Car, 10 3/4"; 495GL Coach, 10 3/4"; 496GL Pullman, 10 3/4"; 497GL Observation, 10 3/4". Track: 12 No. 680 curved, 4 No. 681 straight, 1 No. 675 straight with built-in uncoupling device, 1 No. 684 straight Mail Track Set for 492G Mail Pick-up Car. 1 No. 450 Track Terminal. Cost of 26 pieces if purchased separately, \$35.60.

**No. 4119 TRAIN SET . . \$22.95**



*Watch this Armored Truck Speed into Action—Platform pivots and tilts when you press remote control push button.*

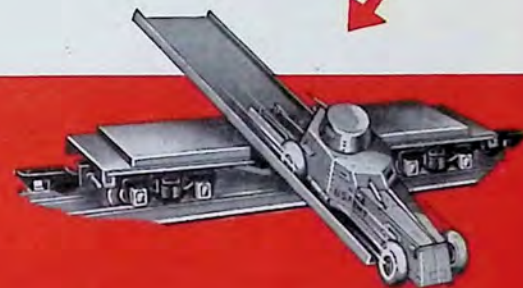

*Fast Mail Delivery—Your moving train grabs our mail sack—throws out another. You direct both actions by remote control.*



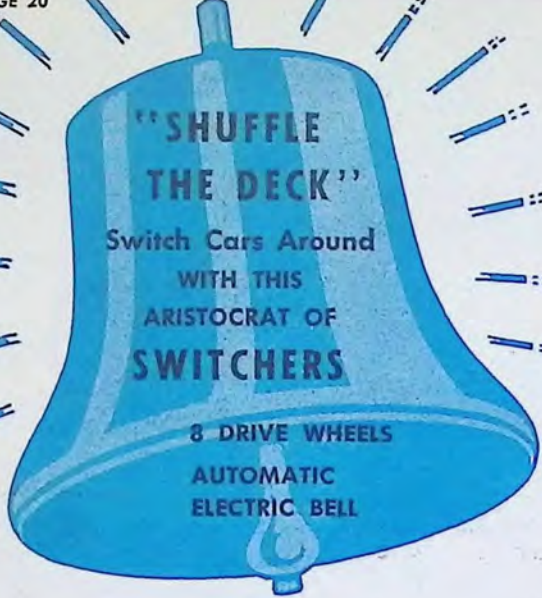

- NICKEL PLATE  
0-8-0**
- ★ 3/16" Scale Model
  - ★ Steam Type
  - ★ Worm Drive
  - ★ Remote Control
  - ★ Automatic Coupling
  - ★ Electric Uncoupling

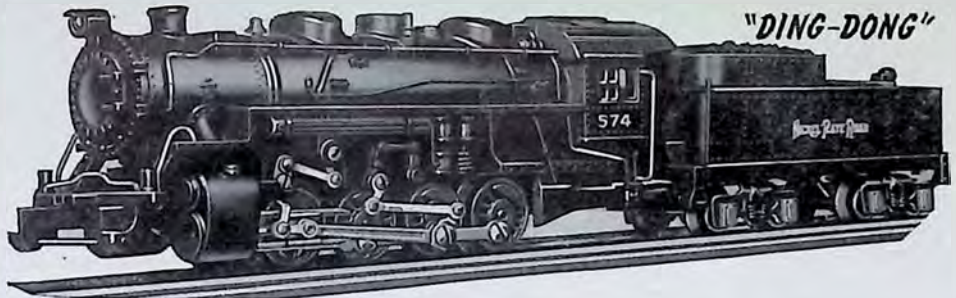

You can switch cars around just as they do in modern classification yards with this superb worm drive Nickel Plate switcher. Both locomotive and tender are die cast. "Ding-dong-ding-dong" goes your automatic electrically operated clanging bell when your locomotive crawls along shunting cars from track to track. Then at high speed your bell automatically cuts out.

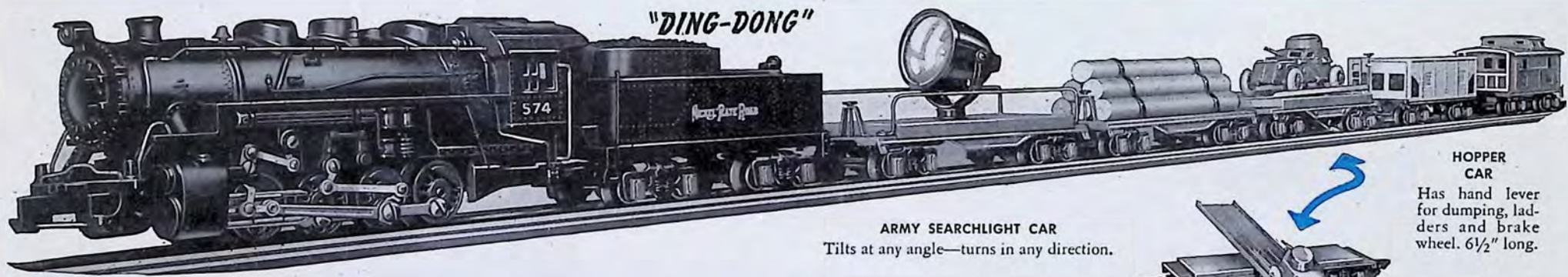

**ARMY SEARCHLIGHT CAR**  
Tilts at any angle—turns in any direction.

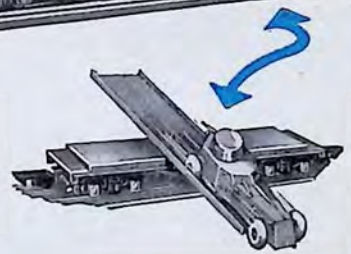

**HOPPER CAR**  
Has hand lever for dumping, ladders and brake wheel. 6 1/2" long.

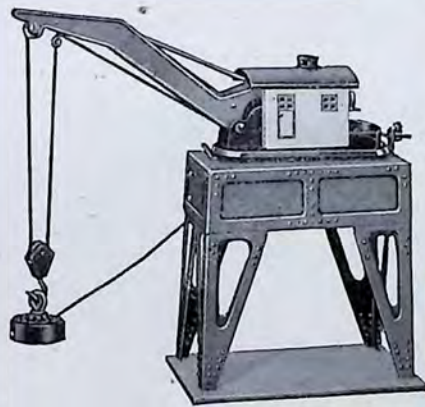

**ARMY AUTOMATIC UNLOADING CAR**  
Armored truck rushes off swiveling, tilting platform when you press remote push button.

**No. 4120 NICKEL PLATE SWITCHER with ELECTRIC BELL**  
27 PIECES—54 1/4" LONG . . . \$25.50

Automatic coupling on front of engine as well as on tender and all cars permits picking up cars anywhere . . . pushing or pulling them. Two headlights—one on engine and one on rear of tender—and swiveling, tilting light on Floodlight car create dazzling illumination for night operation. Dad will want to get in on the fun, too. Armored truck on remote control unloading car is another exciting feature. All five freight cars finished in vivid colored enamel. Eighteen sections of track makes 180" oval. 100 or 150 watt transformer recommended.

Set consists of: No. 574B Locomotive; 573B Tender, 14 3/4" long; 488 Floodlight, 7 7/8"; 482 Log, 7 7/8"; 472 Army Unloading, 7 3/8"; 486 Hopper, 6 1/2"; 484L Caboose, 6 1/2". Track: 12 No. 680 curved, 4 No. 681 straight, 1 No. 675 straight with built-in uncoupling device, 1 No. 683 straight Unloading Track Set for 472 Army Unloading Car, 1 No. 450 Track Terminal. Cost of 27 pieces if purchased separately, \$38.10.

**No. 4120 TRAIN SET . . . \$25.50**

**EVERY RAILROAD YARD NEEDS THIS ELECTROMAGNETIC LOADING AND UNLOADING CRANE.**

# UNION PACIFIC GIANT OF THE RAILS 8 Huge Drive Wheels and all details built to 3/16" scale



**No. 4121 CHALLENGER FREIGHT TRAIN—25 PIECES—62½" LONG . . . . \$25.50**

Every day, giant freight trains like this storm up the steep grades of the Rockies. In the vivid action of this monster's eight drive wheels with eccentric arm triple action piston rods and connecting rods, you feel you are "wheeling" the real thing. The worm drive locomotive with jeweled markers and the tender piled high with imitation coal are die cast and finished in locomotive black. Five freight cars, bright enamel finish, automatic couplers, uncoupled by remote push button. Caboose is 6½" long and illuminated. All others each 7⅝" long. Box car has sliding doors. Log has six realistic logs. Gondola has brake wheel. Tank is equipped with ladders, hand rails and brake wheel. Sixteen sections of track make 160" oval. 100 or 150 watt transformer recommended.

Set consists of: No. 572 Locomotive; 567 Tender, 21½" long; 482 Log, 7⅝"; 478 Box, 7⅝"; 476 Gondola, 7⅝"; 480 Tank, 7⅝"; 484L Caboose, 6½". Track: 12 No. 680 Curved, 3 No. 681 straight, 1 No. 675 straight with built-in uncoupling device. 1 No. 450 Track Terminal. Cost of 25 pieces if purchased separately, \$38.45.

**No. 4121 TRAIN SET . . \$25.50**



## UNION PACIFIC 4-8-4



- ★ 3/16" Scale Model
- ★ Northern Steam Type
- ★ Worm Drive
- ★ Remote Control
- ★ Automatic Coupling
- ★ Electric Uncoupling

Here is a photograph of a real Union Pacific 4-8-4 . . . and an American Flyer scale model. You can scarcely tell which is which.



Add a block signal system to your line and stop and start trains automatically. Light flashes red and green.

**No. 4122 CHALLENGER PASSENGER TRAIN—24 PIECES—66½" LONG . . . . \$25.50**

To be the operator of this flashing train is thrilling fun. Reproduced in actual 3/16" scale, this huge die cast locomotive and tender measure 21½" in length. Worm drive assures instantaneous, super-smooth control at all speeds from slow crawl to a full "highball." Lucite headlight in removable boiler front and jeweled markers add to realistic appearance. Cars are 10¾" long, have automatic couplers and are finished in Tuscan Red enamel, electrically baked. Baggage has sliding doors. Coach is illuminated. Pullman and Observation, illuminated and have imitation window shades. Track makes 160" oval. 100 or 150 watt transformer recommended.

Set consists of: No. 572 Locomotive; 567 Tender, 21½" long; 494T Baggage, 10¾"; 495TL Coach, 10¾"; 496TL Pullman, 10¾"; 497TL Observation, 10¾". Track: 12 No. 680 curved, 3 No. 681 straight, 1 No. 675 straight with built-in uncoupling device. 1 No. 450 Track Terminal. Cost of 24 pieces if purchased separately, \$40.70.

**No. 4122 TRAIN SET . . \$25.50**

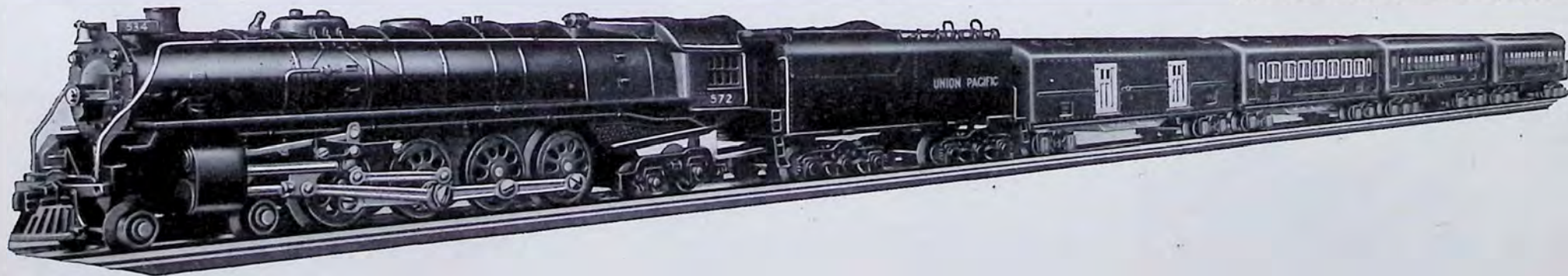

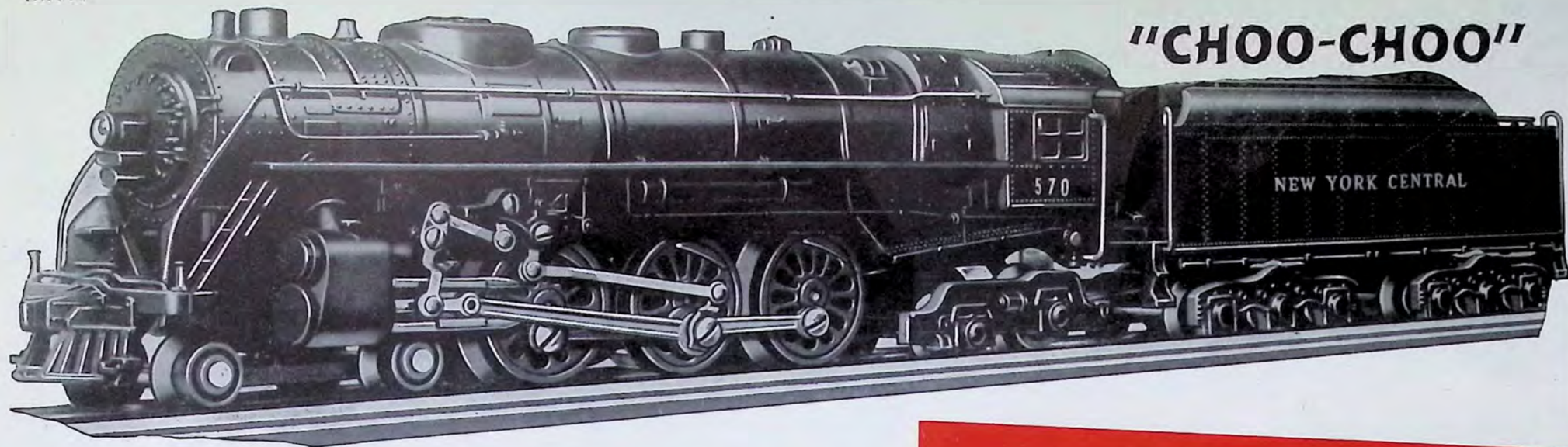

# "CHOO-CHOO"

## HUDSON J-3a 4-6-4



- ★ 3/16" Scale Model
- ★ N. Y. C. Steam Type
- ★ Worm Drive
- ★ Remote Control
- ★ Automatic Coupling
- ★ Electric Uncoupling

This majestic worm drive locomotive with built-in "Choo-Choo" is so realistic in every detail that movies of it in action would convince veteran railroad men that they are *hearing* and *seeing* the real thing. The "choo-choos" are perfectly synchronized to vary in intensity with change in train speed; they continue their throbbing song even when the train is standing still. And so distinct are these thrilling "choo-choos" that you can hear them over 100 feet away.

Both engine and tender are die cast and finished in locomotive black. Six big drive wheels provide tremendous tractive force for high speed operation. Eccentric arm triple action piston rods, side rods and connecting rods, four wheel pony and booster trucks with additional 12 wheels on tender further complete the picture of mighty mechanical power. Locomotive has long beam headlight and removable boiler front. Here, indeed, is a hotshot so perfectly built and so beautifully finished as to delight critical hobbyists—yet priced to be within the reach of boys who want the best.

LOCOMOTIVE No. 570, TENDER No. 563C . . \$21.00

## NEW YORK CENTRAL J-3a HUDSON BATTLESHIP

Built to 3/16" Scale from Railroad Blueprints

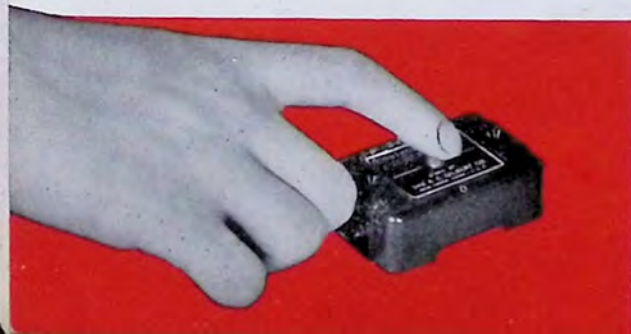

You run your train—uncouple cars—operate dump car and mail pick-up car, all by push button control.

Illuminated trestle bridges provide avenues of travel over rivers and streams. Add one to your set.





● **RED BALL FREIGHT OF THE N. Y. CENTRAL**

**No. 4123 HUDSON J-3a FREIGHT TRAIN WITH "CHOO-CHOO"**

**27 PIECES—58½" LONG . . \$27.95**

Hauled by the locomotive described on the opposite page, this N. Y. Central freight presents a stirring spectacle. All five cars are accurately built to 3/16" scale, finished in bright colored electrically baked enamel and have automatic couplers. Dump car with imitation coal dumps into bin by pressing remote control button. Wrecker has cab and boom which turn on swivel base; hook raises and lowers. Caboose is illuminated. Box car has sliding doors. Flat car with girder. Track makes 180" oval. 100 or 150 watt transformer recommended.

Set consists of: No. 570 Locomotive; 563C Tender, 19" long; 474 Dump, 7½"; 483 Girder, 7½"; 481 Wrecker, 7½"; 478 Box, 7½"; 484L Caboose, 6½". Track: 12 No. 680 curved, 4 No. 681 straight, 1 No. 675 straight with built-in uncoupling device, 1 No. 683 straight Unloading Track Set for 474 Dump car, 1 No. 450 Track Terminal. Cost of 27 pieces if purchased separately, \$40.60.

**No. 4123 TRAIN SET . . \$27.95**

**No. 4124 HUDSON J-3a PASSENGER TRAIN WITH "CHOO-CHOO"**

**26 PIECES—64" LONG . . \$27.95**

Rolling down the track to the merry rhythm of its "choo-choos," this crack limited brings you thrill after thrill. See how that Mail Pick-up Car swings out arm to gather in a sack of mail while train is in full motion and at same time automatically tossing out another sack. Pullman and observation cars illuminated. Shades in windows and six wheel trucks. All cars finished in Tuscan enamel with white and nickel trim. Eighteen sections of 10" track make 180" oval. 100 or 150 watt transformer recommended.

Set consists of: No. 570 Locomotive; 563C Tender, 19" long; 492T Automatic Mail Pick-up, 10¾"; 495TL Coach, 10¾"; 496TL Pullman, 10¾"; 497TL Observation, 10¾". Track: 12 No. 680 curved, 4 No. 681 straight, 1 No. 675 straight with built-in uncoupling device, 1 No. 684 straight Mail Track Set, for 492G Mail Pick-up Car, 1 No. 450 Track Terminal. Cost of 26 pieces if purchased separately, \$40.60.

**No. 4124 TRAIN SET . . \$27.95**



**HEAR IT "CHOO-CHOO"**  
in your own home just as real trains  
"choo-choo" along the Hudson River

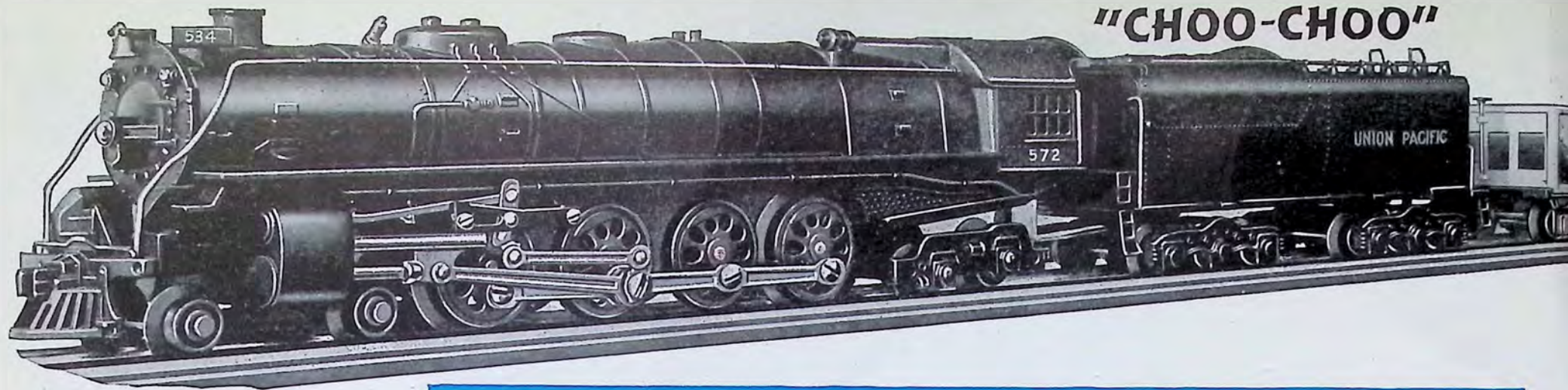

# "CHOO-CHOO"

No. 4125 NORTHERN FREIGHT TRAIN WITH "CHOO-CHOO" 27 PIECES—61½" LONG . . . . \$32.95

Filling the air with its realistic-sounding "choo-choos" and with its colossal boiler rocking and swaying over 16 racing wheels, this Union Pacific 3/16" scale model locomotive and five car drag capture the full pageantry of railroading. That Army Unloading Car is the latest word in mechanization. Just press a remote control push button and the platform swivels, tilts and automatically unloads the armored truck. That big searchlight which turns on its base and tilts in any direction. That wrecker has a cab and boom that turn on swivel base; hook raises and lowers. That hopper car has a hand lever for dumping. The caboose is illuminated. Automatic couplers throughout. Eighteen sections of track make 180" oval. 100 or 150 watt transformer recommended.

Set consists of: No. 572 Locomotive; 567C Tender, 21½" long; 486 Hopper, 6½"; 472 Army Unloading, 7½"; 488 Floodlight, 7½"; 481 Wrecker, 7½" 484L Caboose, 6½". Track: 12 No. 680 curved, 4 No. 681 straight, 1 No. 675 straight with built-in uncoupling device, 1 No. 683 straight Unloading Track Set for 472 Army Unloading Car. 1 No. 450 Track Terminal. Cost of 27 pieces if purchased separately, \$46.60.

No. 4125 TRAIN SET . . \$32.95

## MIGHTY POWER through the Rockies



Hear the "CHOO-CHOOS" of  
this Union Pacific Scale Model  
echo and re-echo - Watch those  
8 drive wheels pound the track

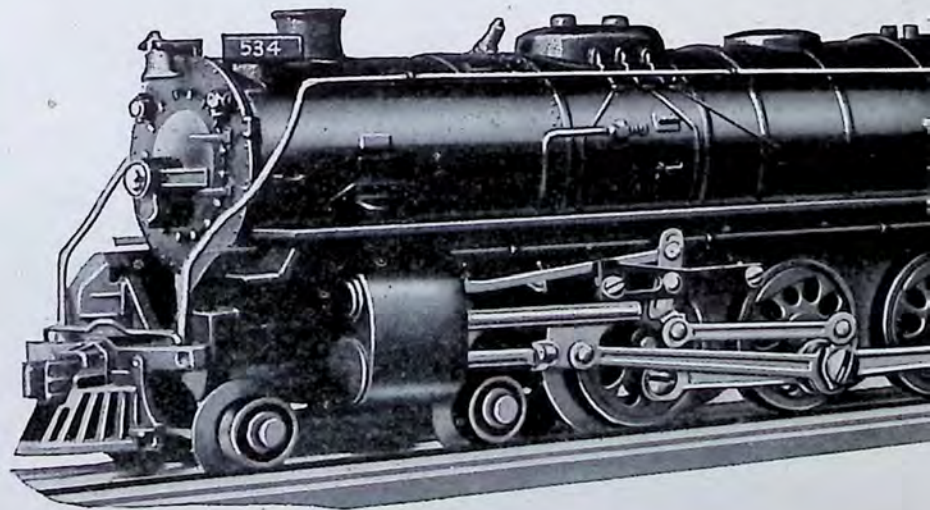

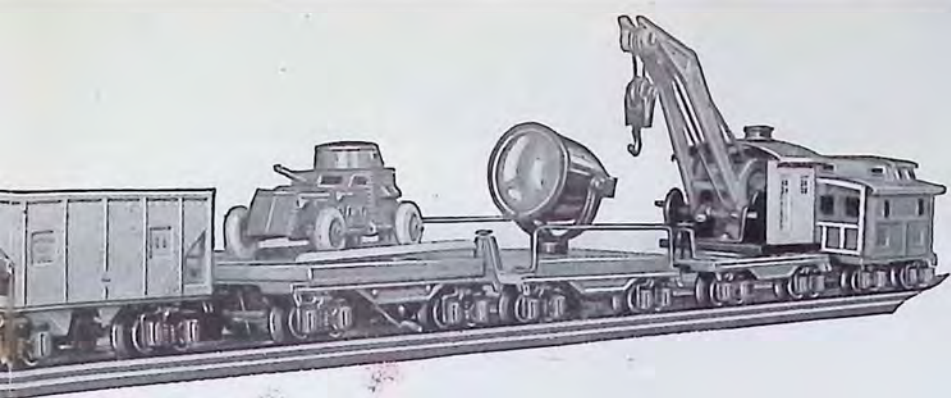

**ALL THESE FINE FEATURES INCLUDED WITH THESE SUPERB TRAINS**



**REMOTE CONTROL**  
Stop and start your train forward or reverse — without touching locomotive.



**3/16" SCALE MODEL**  
Locomotive, tender and all cars built to 3/16" scale from railroad blueprints.



**AUTOMATIC COUPLERS**  
Standard equipment on every car and every tender. Mimet full action. Cars couple anywhere.

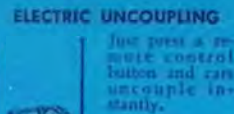

**ELECTRIC UNCOUPLING**  
Just press a remote control button and cars uncouple instantly.



**WORM DRIVE**  
Amazingly quiet — gives smooth even pull — banishes jerking or jumping when starting.

**LUCITE ELECTRIC HEADLIGHT**



Casts realistic beam and creates spectacular effect on train when operating at night.



- UNION PACIFIC 4-8-4**
- ★ 3/16" Scale Model
  - ★ Northern Steam Type
  - ★ Worm Drive
  - ★ Remote Control
  - ★ Automatic Coupling
  - ★ Electric Uncoupling

**No. 4126 NORTHERN PASSENGER TRAIN WITH "CHOO-CHOO" — 26 PIECES — 66 1/2" LONG . . . . . \$32.95**

Built for fast mail and passenger service, this sleek limited measures 66 1/2" in length. Power is transmitted through smooth-pulling worm drive, making the eight burly drive wheels and eccentric arm triple action piston rods perform their tasks with perfect precision. Built-in "Choo-Choo" brings to your ears the stirring song of the rails . . . fast and turbulent at high speeds—slow and deep throated when locomotive idles. A brand new feature is the Automatic Mail Pick-up car. Press a remote control button and it snatches up one sack of mail and automatically tosses out another. Coach, Pullman and Observation cars are illuminated, finished in red enamel. Eighteen sections of track make 180" oval. 100 or 150 watt transformer recommended.

Set consists of: No. 572 Locomotive; 567C Tender, 21 1/2" long; 492R Mail Pick-up Car, 10 3/4"; 495RL Coach, 10 3/4"; 496RL Pullman, 10 3/4"; 497RL Observation, 10 3/4". Track: 12 No. 680 curved, 4 No. 681 straight, 1 No. 675 straight with built-in uncoupling device, 1 No. 684 straight Mail Track set for No. 492R Mail Pick-up car, 1 No. 450 Track Terminal. Cost of 26 pieces if purchased separately, \$45.60.

**No. 4126 TRAIN SET . . . \$32.95**

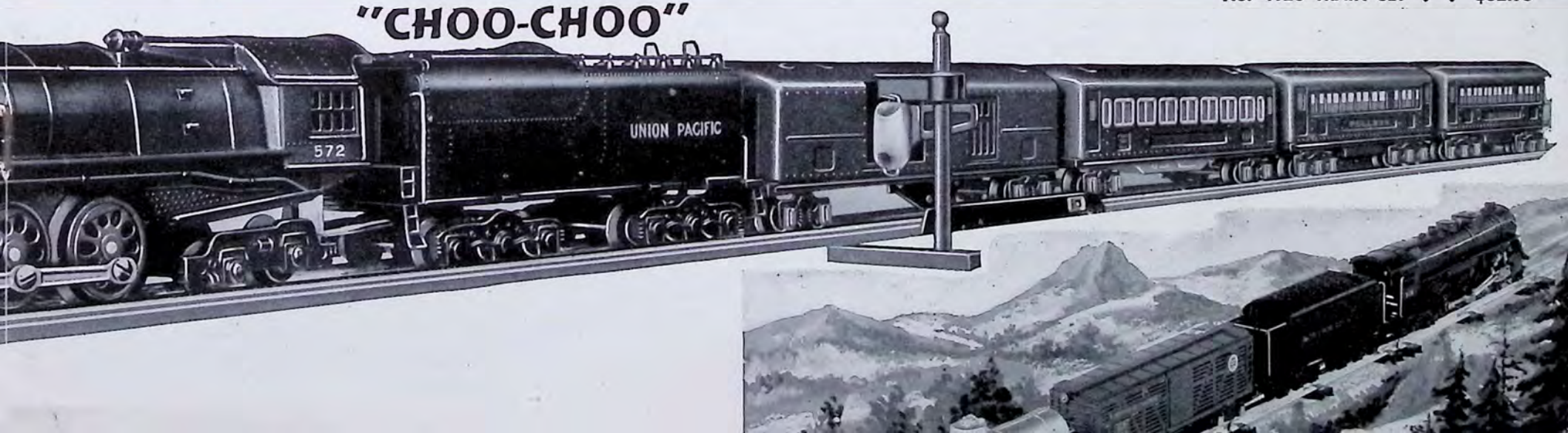

# DIRECTIONAL REMOTE CONTROL

THE AMERICAN FLYER INVENTION THAT IS  
REVOLUTIONIZING MINIATURE RAILROADING

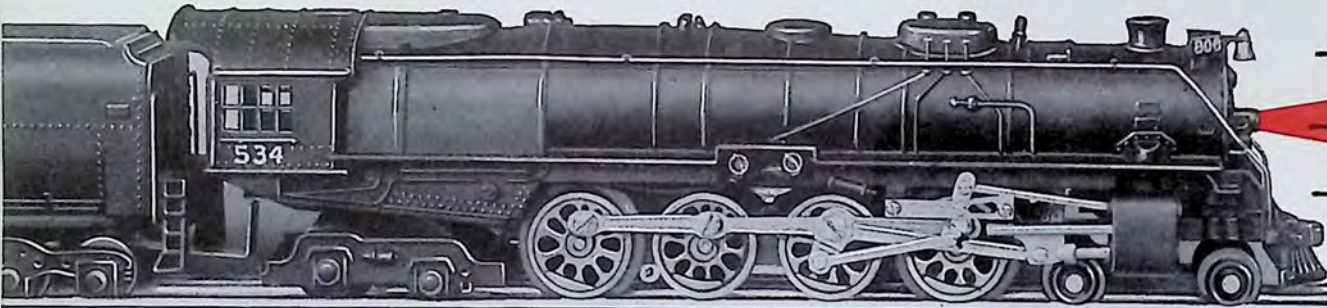

→ The **ONLY** Remote Control system that  
Banishes Backing-up after each stop  
→ Headlight illuminated at all times

← **STARTING LINE**

DIRECTIONAL REMOTE CONTROL OPERATES ON A.C. 60 CYCLES ONLY. NON-OPERATIVE ON 25 CYCLES. NON-OPERATIVE ON D.C. WITH A REDUCER. TO OPERATE ON D.C. NO. 10 INVERTER AND A TRANSFORMER MUST BE USED.

## JUST TURN ON TRANSFORMER THROTTLE AND YOUR TRAIN INSTANTLY GLIDES FORWARD AFTER A STOP . . . . .

Picture your train pounding down the iron pike at 75 scale miles per hour. A station looms ahead. You ease her to a stop . . . Now you give the highball signal to continue your run. Note this point carefully. With ordinary electric trains your train must *first back up* before it can go forward. Can you imagine a real train doing that? Of course not. And you don't have to jockey back and forth with an American Flyer either.

Thanks to its new Directional Remote Control, it glides forward or backward or stands still—with headlight on—the moment you touch the control.

When used in connection with Block Signals, a-Koostikin Talking Railroad Station and other equipment for automatically stopping trains, Directional Remote Control assures trains resuming run in the same direction in which they were last traveling—*unless* you intentionally change direction by pressing control button.

Directional Remote Control comes only with trains Nos. 4127, 4128, 4129, 4130, 4131, 4132, 4133 and all HO Gauge Trains.

## SPECTACULAR TWO TRAIN OPERATION ON SINGLE TRACK NOW POSSIBLE

Two trains are operating on the same track in the same direction. Train A operates on Standard Remote Control, Train B operates on Directional Remote Control. Train B starts to overtake Train A; a rear end collision seems imminent. But no—by Directional Remote Control you stop Train B, as Train A continues on. When a safe distance ahead, you let Train B resume its run. Directional Remote Control enables you to stop Train B without stopping Train A. Train B controlled by Directional Control button, Train A by transformer throttle. You can instantly make either train go forward, backwards or stop regardless of the direction in which other is running.

No. 540 Directional Control Button which comes with Train Sets 4127, 4128, 4129, 4130, 4131, 4132 and 4133 must be used for locomotive operation.

## THE OLD WAY



STARTING  
LINE

Train running in forward direction is stopped. Before it can go forward again, it must first back up. Directional Remote Control banishes this waste motion and allows train to proceed in same direction without reversing.

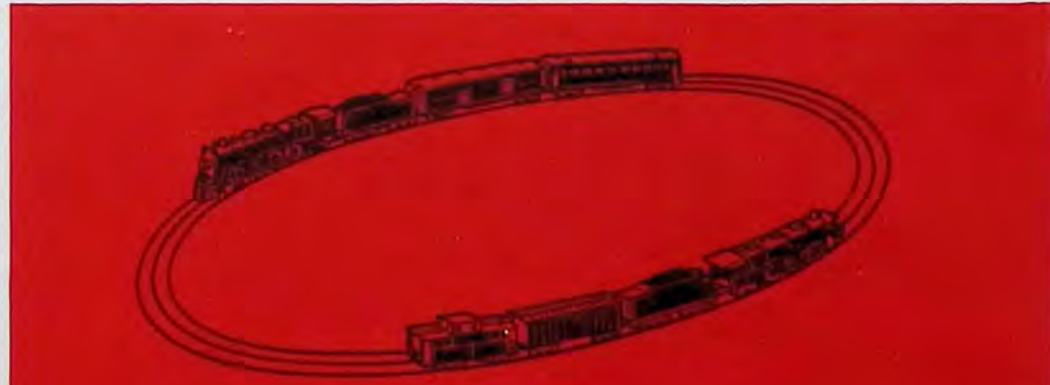

# The PENNSY'S SUPER POWER K-5

2 1/2" CAST 1/16" SCALE MODEL THAT LOOKS,

PAGE 11

RUNS AND SOUNDS LIKE THE REAL THING

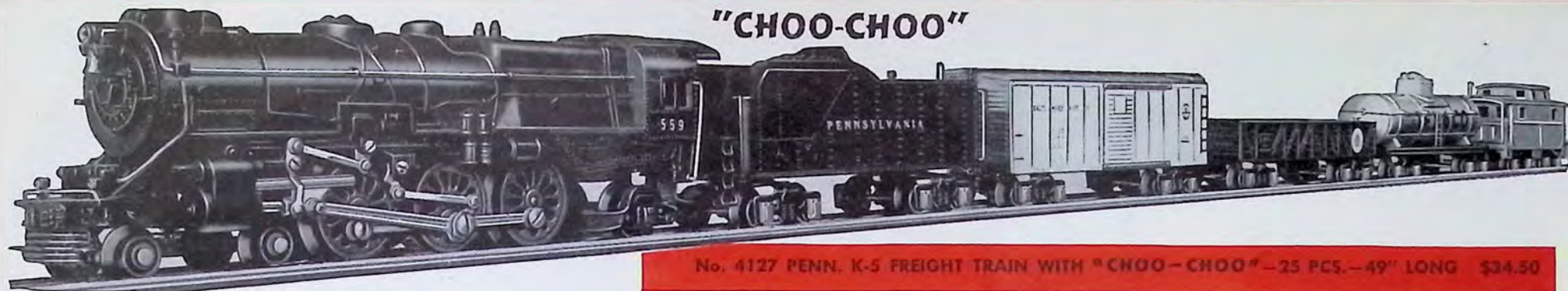

No. 4127 PENN. K-5 FREIGHT TRAIN WITH "CHOO-CHOO"—25 PCS.—49" LONG \$34.50

You operate this mainliner by the marvelous, realistic Directional Remote Control described on the opposite page. Power is transmitted in an even flow through the precision built worm drive . . . and with each change in speed you hear a reverberating chorus of choo-choos. Locomotive, tender and all cars are die cast and accurately built to 3/16" scale from actual railroad blueprints. Caboose is 6" long and illuminated. All other cars 7 1/2" long. Every car has automatic couplers, electric uncoupling and electrically baked enamel finish. Track makes 160" oval. 150 or 250 watt transformer recommended.

Set consists of: No. 559 Locomotive; 558C Tender, 17 3/4" long; 506 Box, 7 1/2"; 504 Gondola, 7 1/2"; 512 Tank, 7 1/2"; 516 Caboose, 6". Track: 12 No. 680 curved, 3 No. 681 straight, 1 No. 675 straight with built-in uncoupling device. 1 No. 450 Track Terminal, 1 No. 540 Directional Control Button. Cost of 25 pieces if purchased separately, \$44.70.

No. 4127 TRAIN SET . . \$34.50



There's no guesswork about these automatic couplers—they always work.

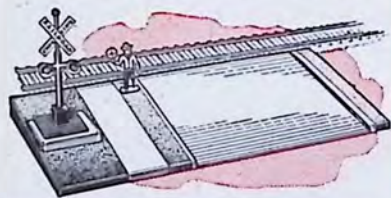

Bell Danger Signal. Doubly realistic! Bell rings—light blinks when train passes. Be sure to add this feature.

## PENNSYLVANIA 4-6-2



- ★ Directional Remote Control
- ★ 3/16" Scale Model
- ★ Pacific Steam Type
- ★ Worm Drive
- ★ Automatic Coupling
- ★ Electric Uncoupling
- ★ Die Cast Cars

## No. 4128 PENNSYLVANIA K-5 PASSENGER TRAIN WITH "CHOO-CHOO"

24 PIECES—54 1/2" LONG . . \$34.50

With the stirring noise of its choo-choos in your ears . . . with one hand on the throttle and the other on the magic Directional Control button, you will almost feel you are sitting in the cab of this famous crack express. Lucite headlight and jeweled markers. All cars are die cast, 12" long, built to 3/16" scale and finished in Tuscan Red enamel, electrically baked. Every car is illuminated. Baggage and club car has sliding and hinged doors; Pullmans have hinged doors. All have 6 wheel trucks. Automatic couplers, which can be uncoupled instantly by remote control. Track makes 160" oval of 40" diameter, 150 or 250 watt transformer recommended.

Set consists of: No. 559 Locomotive; 558C Tender, 17 3/4" long; 521T Baggage and Club, 12"; 2 524T Pullmans, 12". Track: 12 No. 680 curved, 3 No. 681 straight, 1 No. 675 straight with built-in uncoupling device. 1 No. 450 Track Terminal, 1 No. 540 Directional Control Button. Cost of 24 pieces if purchased separately, \$45.20.

No. 4128 TRAIN SET . . \$34.50



# SUPER-DETAIL . . . PRECISION BUILT . . . 3/16" SCALE MODELS

## NICKEL PLATE 0-8-0



- ★ Directional Remote Control
- ★ 3/16" Scale Model
- ★ Steam Type
- ★ Worm Drive
- ★ Automatic Coupling
- ★ Electric Uncoupling
- ★ Die Cast Cars

## N. Y. CENTRAL 4-6-4



- ★ Directional Remote Control
- ★ 3/16" Scale Model
- ★ Steam Type
- ★ Worm Drive
- ★ Automatic Coupling
- ★ Electric Uncoupling
- ★ Die Cast Cars

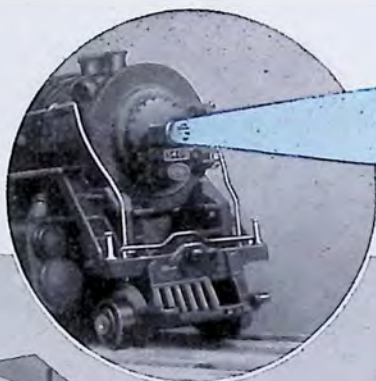

Turn off the house lights and this Lucite headlight makes your train look like a midnight express.

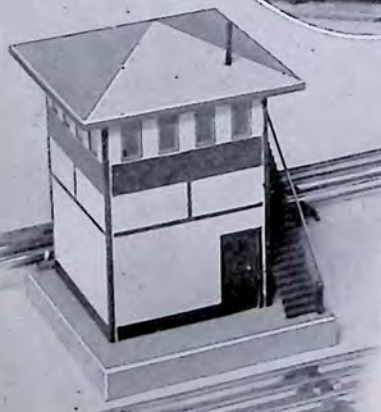

Add this realistic, two story illuminated signal tower to your line.



## No. 4129 YARD GOAT SWITCHER WITH ELECTRIC BELL

25 PIECES—45" LONG . . . \$37.00

Railroad's busiest locomotive. Built-in electric bell clangs a warning. Directional Remote Control and worm drive give you instantaneous mastery over both speed and direction—so essential in realistic switching operations. Die cast 3/16" scale construction throughout. Eight mighty drive wheels with eccentric arm triple action piston rods, side rods and connecting rods. Lucite electric headlight on front of locomotive and rear of tender. Illuminated caboose. Automatic coupling on front of locomotive, tender and all cars. Electrical uncoupling. Cars have electrically baked enamel finish. Track makes 160" oval. 150 or 250 watt transformer recommended.

Set consists of: No. 575B Locomotive; 576B Tender, 14 3/4" long; 508 Hopper, 6 1/2"; 510 Cattle, 7 1/2"; 512 Tank, 7 1/2"; 516 Caboose, 6". Track: 12 No. 680 curved, 3 No. 681 straight, 1 No. 675 straight with built-in uncoupling device. 1 No. 450 Track Terminal, 1 No. 540 Directional Control Button. Cost of 25 pieces if purchased separately, \$47.70.

No. 4129 TRAIN SET . . . \$37.00

## No. 4130 N. Y. C. J-3a FREIGHT TRAIN WITH "CHOO-CHOO"

25 PIECES—50 3/4" LONG . . . \$39.50

Listen to the slow rumble of those "choo-choos" as this die cast freight waits for you to open the throttle . . . hear the "choo-choos" mount in intensity as your train glides forward . . . then burst into a roaring crescendo at top speed. With such glorious sound effects and with Directional Remote Control to give you instantaneous mastery over forward or reverse train operation, this set is tops in realism. Die cast cars have automatic couplers, baked enamel finish. Wrecker has revolving cab; boom with hook that raises and lowers. Caboose is illuminated. Track makes 160" oval. 150 or 250 watt transformer recommended.

Set consists of: No. 531 Locomotive; 563C Tender, 19" long; 506 Box, 7 1/2"; 504 Gondola, 7 1/2"; 514 Wrecker, 7 1/2"; 516 Caboose, 6". Track: 12 No. 680 curved, 3 No. 681 straight and 1 No. 675 straight with built-in uncoupling device. 1 No. 450 Track Terminal, 1 No. 540 Directional Control Button. Cost of 25 pieces if purchased separately, \$50.70.

No. 4130 TRAIN SET . . . \$39.50

## No. 4131 N. Y. C. J-3a PASSENGER TRAIN WITH "CHOO-CHOO"

24 PIECES—56" LONG . . . \$39.50

A die cast 3/16" scale replica of the crack limiteds that speed across the Empire State, this train is operated by Directional Remote Control . . . has built-in "Choo-Choo" synchronized to change tone and tempo with every change in train speed. Power is transmitted through smooth-pulling worm drive to six giant drive wheels with eccentric arm triple action piston rods, side rods and connecting rods. Lucite headlight and electric lights in all cars create spectacular night effect. Pullmans have hinged doors. Automatic couplers can be uncoupled by remote push button. Track makes 160" oval. 150 or 250 watt transformer recommended.

Set consists of: No. 531 Locomotive; 563C Tender, 19" long; 521G Baggage and Club, 12"; 2 524G Pullmans, 12". Track: 12 No. 680 curved, 3 No. 681 straight, 1 No. 675 straight with built-in uncoupling device. 1 No. 450 Track Terminal, 1 No. 540 Directional Control Button. Cost of 24 pieces if purchased separately, \$49.70.

No. 4131 TRAIN SET . . . \$39.50

and . . . DIE-CAST FROM FRONT END TO REAR END



*"DING-DONG"*

No. 4129 YARD GOAT SWITCHER WITH ELECTRIC BELL . . . . \$37.00

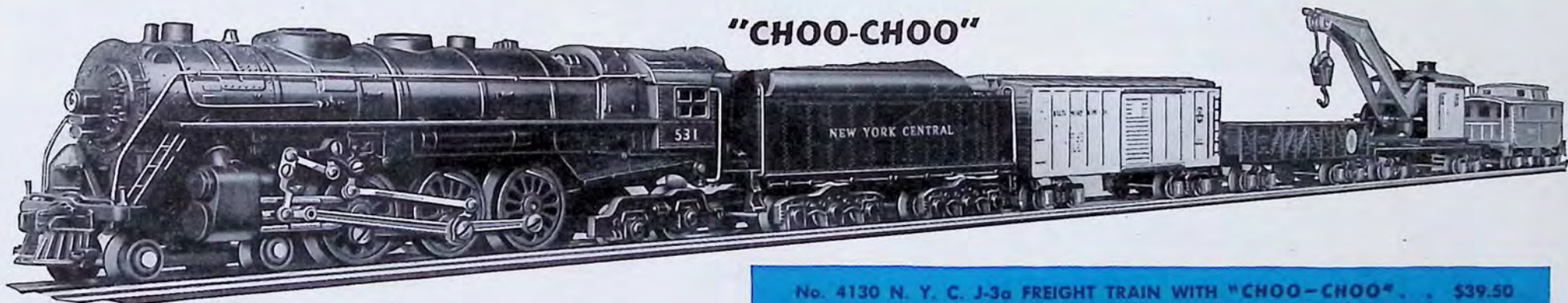

*"CHOO-CHOO"*

No. 4130 N. Y. C. J-3a FREIGHT TRAIN WITH "CHOO-CHOO" . . \$39.50



*"CHOO-CHOO"*

No. 4131 N. Y. C. J-3a PASSENGER TRAIN WITH "CHOO-CHOO" . \$39.50

# WONDER OF THE WEST • MAMMOTH UNION PACIFIC

## "CHOO-CHOO"

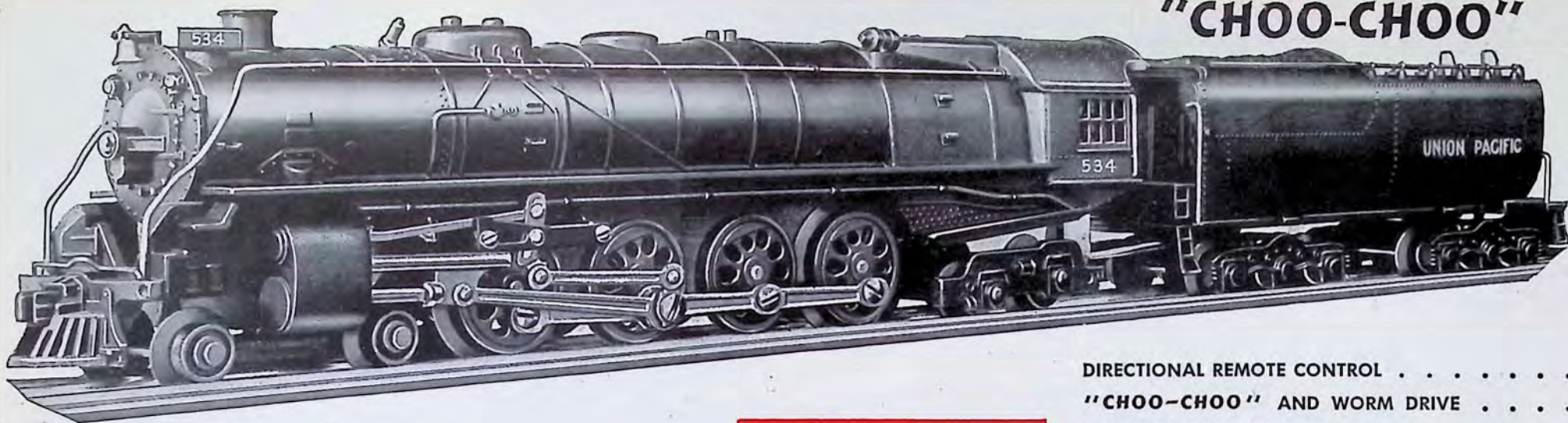

**DIRECTIONAL REMOTE CONTROL . . . . .**  
**"CHOO-CHOO" AND WORM DRIVE . . . . .**  
**GIVE FULL OPERATING REALISM . . . . .**

Picture yourself wheeling this super power battleship. At your finger tips are your throttle, for controlling speed—and the Directional Remote control button for controlling the direction of your train. Turn on the power—and while your train is standing still—a stream of slow pulsed "choo-choos" greet your ears. Open the throttle! Power surges through the worm gear drive, wheels turn and the "choos-choos" come in quickened restless snorts. Open your throttle wide and the "choos-choos" become the tempestuous melody of smoke and steam harnessed to mechanical power . . . Now stop your train. If you want it to continue in the same direction, just open your throttle again. If you want to *change* its direction, first press the Directional Remote Control button, then open your throttle. No other remote control system is so simple and realistic.

**LOCOMOTIVE No. 534—TENDER No. 567C . \$31.00**

### UNION PACIFIC 4-8-4



- ★ Directional Remote Control
- ★ 3/16" Scale Model
- ★ Northern Steam Type
- ★ Worm Drive
- ★ Automatic Coupling
- ★ Electric Uncoupling
- ★ Die Cast Cars

Directional Remote Control at your finger tip. Press button to change direction of train.



**SEE HOW THESE EIGHT HUGE DRIVE WHEELS HUG THE RAILS**

You can tell by just looking at those massive drive wheels that they have tremendous tractive force. And to see them thundering over the rails—with their eccentric arm triple action piston rods, side rods, and connecting rods dizzily flashing back and forth, is a spectacle that brings a glow of pride to every boy engineer . . . Dad, too. Hurrying to keep pace with the 8 drive wheels are the 4 pony and 4 booster truck wheels . . . and an additional 12 wheels in double die cast trucks on the tender. Thus locomotive and tender have a total of 28 wheels and measure 21½" in length. Both locomotive and tender are die cast—built to 3/16" scale from railroad blueprints—and finished in authentic locomotive black.

# B DRIVE WHEEL HOTSHOT THAT HAS EVERYTHING



**No. 4132 UNION PACIFIC FREIGHT TRAIN WITH "CHOO-CHOO" 25 PIECES—52 1/2" LONG . \$46.50**

Die cast to actual 3/16" scale from its headlight to the last detail of the illuminated caboose, this powerful Rocky Mountain freight represents an outstanding achievement in realistic appearance and operation. Equally realistic is the stirring sound of its "choo-choos." Directional Remote Control, worm drive, automatic couplers and electric uncoupling enable you to make up your train and send it pounding down the main line in true railroad style. Cars finished in electrically baked enamel. Sixteen sections of track make 160" oval. 150 or 250 watt transformer recommended.

Set consists of: No. 534 Locomotive; 567C Tender, 21 1/2" long; 510 Cattle, 7 1/2"; 508 Hopper, 6 1/2"; 512 Tank, 7 1/2"; 516 Caboose, 6". Track: 12 No. 680 curved, 3 No. 681 straight and 1 No. 675 straight with built-in uncoupling device, 1 No. 450 Track Terminal, 1 No. 540 Directional Control Button. Cost of 25 pieces if purchased separately, \$54.70.

**No. 4132 TRAIN SET . . \$44.50**

**No. 4133 UNION PACIFIC PASSENGER TRAIN WITH "CHOO-CHOO" 24 PIECES—59" LONG . \$44.50**

Headed by the handsomely groomed locomotive described on the opposite page, this superb limited is the wonder and glory of every boy who owns one. Locomotive has Lucite headlight. All cars are illuminated. Baggage and club car has sliding and hinged doors. Pullmans have hinged doors. All cars die cast, 12" long and finished in green enamel. Automatic couplers and electric uncoupling. Worm drive and Directional Remote Control assure smooth, quiet operation and instant control in maintaining or changing direction of train. "Choo-Choo" gives realistic sound effects. Track makes 160" oval. 150 or 250 watt transformer recommended.

Set consists of: No. 534 Locomotive; 567C Tender, 21 1/2" long; 521G Baggage and Club, 12"; 2 524G Pullmans, 12". Track: 12 No. 680 curved, 3 No. 681 straight and 1 No. 675 straight with built-in uncoupling device, 1 No. 450 Track Terminal, 1 No. 540 Directional Control Button. Cost of 24 pieces if purchased separately, \$54.70.

**No. 4133 TRAIN SET . . \$44.50**



Have this illuminated billboard with whistling unit along your right of way. The only whistle that can be used with Directional Remote Control.



## "CHOO-CHOO"

## Suggested TRACK LAYOUTS - Lay your rails to fit your own right of way

ALL "O" GAUGE TRACK  
ONE STANDARD QUALITY  
ONE STANDARD RADIUS  
INTERCHANGEABLE



No. 2—Space 40" x 90"  
Track 20 Curve 6 Straight and  
2 pair of Switches



No. 3—Space 40" x 100"  
Track 14 Curve 12 Straight  
1-1/2 Straight 1 pr. of Switches



No. 6—Space 40" x 93"  
Track 18 Curve 4 Straight and  
1 Crossover



No. 11—Space 40" x 90"  
Track 20 Curve and 2 Straight



No. 15—Space 45" x 90"  
Track 22 Curve 6 Straight and  
2 pr. of Switches



No. 5—Space 46" x 100" Track  
21 Curve 14 Straight  
4-1/2 Straight 2-1/2 Curve  
1 Crossover and 1 pair of  
Switches



No. 9—Space 50" x 90"  
Track 32 Curve 18 Straight  
and 2 pr. of Switches



No. 12—Space 50" x 90"  
Track 20 Curve  
10 Straight and 1 pr. of  
Switches

A fine layout for a long room. Use tables in two corners with a connecting shelf against the wall. Single or double track (as shown). Main line with reversing loop at each end.



No. 13—Space 70" x 140"  
Track Required 28" Curve  
22 Straight 3-1/2 Straight  
3 pr. of Switches



No. 14—Space 60" x 85"  
Track 20 Curve  
10 Straight and 1 pr. of  
Switches



No. 17—Space 60" x 100"  
Track 22 Curve 6 Straight  
1 pair of Switches



No. 1—Space 67-1/2" x 105" Track 24 Curve  
11 Straight 2-1/2 Straight 1 Crossover  
Train Control Crossover  
This layout allows the operation of two  
trains at the same time. A Train Control  
Crossover is used to prevent collisions.

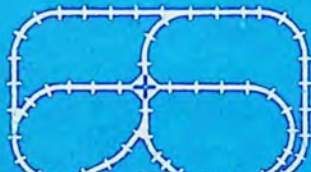

No. 4—Space 70" x 115" Track  
24 Curve 22 Straight 5-1/2 Straight  
3 pr. of Switches 1 Crossover



No. 7—Space 65" x 70"  
Track 19 Curve 5 Straight  
1 Crossover 2-1/2 Straight  
1 pr. Switches

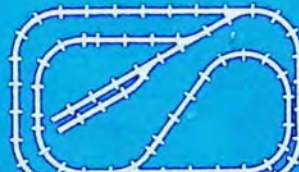

No. 18—Space 70" x 110"  
Track 28 Curve 39 Straight  
4-1/2 Straight 3 pr. of Switches



No. 23—Space 60" x 120"  
Track 24 Curve 32 Straight  
2-1/2 Straight 2 pair of Switches



No. 8—Space 50" x 80"  
Track 16 Curve 12 Straight and  
1 pr. of Switches

For two train operation with  
Train Control Crossover

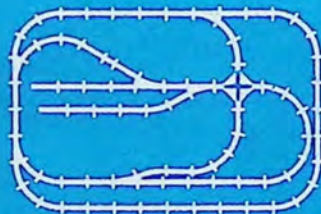

No. 10—Space 80" x 120"  
Track Required 30 Curve 42 Straight  
1-1/2 Straight 3 pr. of Switches  
1 Crossover

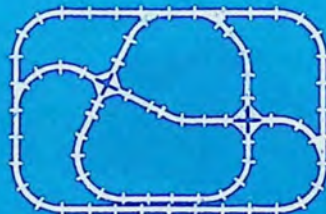

No. 16—Space 80" x 120"  
Track 28 Curve 30 Straight  
3-1/2 Straight 2 pair of Switches  
2 Crossovers

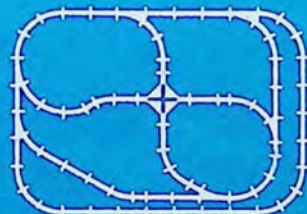

No. 19—Space 80" x 110"  
Track 29 Curve 28 Straight 6-1/2 Straight  
3 pair of Switches 1 Crossover

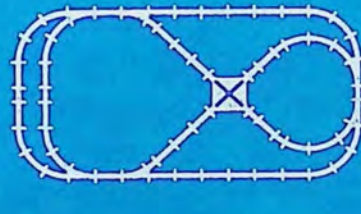

No. 20—Space 65" x 130" Track 22 Curve  
4-1/2 Curve 26 Straight 5-1/2 Straight  
3 pair of Switches 1 Crossover

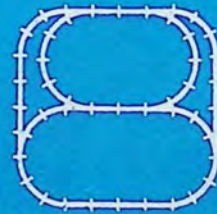

No. 21—Space 80" x 80"  
Track 24 Curve  
14 Straight  
3 pair of Switches



No. 22—Space 62" x 80"  
Track 22 Curve 4-1/2 Curve  
4 Straight 1 - 602 Crossover  
1-604 Train Control Crossover

# NEW SUPER-POWER "SAFETY first" TRANSFORMERS [ OPERATE ONLY ON ALTERNATING CURRENT ]



No. 78—"SAFETY FIRST" TRANSFORMER  
75 WATTS—60 CYCLES ..... \$5.50

Instrument panel shows "miles per hour" train is set for. Red pilot light shines when short circuit occurs—stays on till short is corrected. Approved by Underwriters' Laboratories.



- No. 5—50 WATTS—60 CYCLES ..... \$2.50
- No. 6—75 WATTS—60 CYCLES ..... \$3.50
- No. 5A—50 WATTS—25 CYCLES ..... \$3.00
- No. 6A—75 WATTS—25 CYCLES ..... \$4.00

Instrument panel shows "miles per hour." No. 11 Transformer Circuit Breaker recommended for protective purposes. Approved by Underwriters' Laboratories.



No. 5B "SAFETY FIRST" TRANSFORMER—  
50 WATTS—60 CYCLES ..... \$3.95

Built-in circuit breaker protects fixed as well as variable voltage. Instrument panel shows "miles per hour" train is set for. Has Engineer's Speed Control Throttle and re-set button. Approved by Underwriters' Laboratories.



No. 12B "SAFETY FIRST" NEW TWIN CONTROL TRANSFORMER—250 WATTS—60 CYCLES ..... \$14.50

Designed for heavy duty on large track layouts with numerous accessories. Dual speed control throttles show "miles per hour." Will operate from two to four trains on the same or two separate layouts and at different rates of speed. Has built-in circuit breaker and equipped with red and green pilot lights and handy off-and-on switch.

No. 9B "SAFETY FIRST" NEW TWIN CONTROL TRANSFORMER — 150 WATTS—60 CYCLES ..... \$10.95

Dual Speed Control Levers. Will operate two or three trains on the same or two separate layouts. Makes possible operation of trains on separate track layouts at different rates of speed. Off-and-on switch located on transformer—handiest possible place.

"Safety First" is the motto of railroads, and the motto of American Flyers' engineers in perfecting these new super-power "Safety First" transformers. Output limited to 15 volts, materially reducing danger of burning out lights, motors, etc. Built-in circuit breakers protects fixed as well as variable voltage. Red pilot light flashes on when short circuit occurs—stays on until short is corrected. Green pilot light shines when current is passing through transformer. Simplified three terminal post arrangement eliminates complicated equipment circuits. Engineer's Throttle Control standard on all models. While especially made to operate American Flyer trains, these transformers are equally good in the operation of other electrical toys.

TRANSFORMER	RECOMMENDED FOR TRAIN SETS
Nos. 5, 5A, 5B, 6, 6A, 7B	Nos. 4101, 4102, 4103, 4104
Nos. 6, 6A, 7B, 8B	Nos. 4105, 4106, 4107, 4108, 4109, 4110, 4111, 4112, 4113, HO-103, HO-104, HO-105
Nos. 8B, 9B	Nos. 4114, 4115, 4116, 4117, 4118, 4119, 4120, 4121, 4122, 4123, 4124, 4125, 4126
Nos. 9B, 12B	Nos. 4127, 4128, 4129, 4130, 4131, 4132, 4133

Note—It is advisable to secure the higher wattage transformer to provide for future additions to your railroad.

No. 8B "SAFETY FIRST" TRANSFORMER—  
100 WATTS—60 CYCLES ..... \$6.95

Has green "tell tale" pilot light which shines as long as current is passing through the transformer and a red pilot light which flashes red when a short circuit occurs. Instrument panel shows "miles per hour" train is set for. Approved by Underwriters' Laboratories.



No. 11 "SAFETY FIRST" TRANSFORMER  
CIRCUIT BREAKER ..... \$1.50

Protects transformer when short circuit occurs. Red light shines when there's trouble. Recommended for use with transformers Nos. 5, 5A, 6 and 6A.



No. 10 "SAFETY FIRST" D. C.  
INVERTER ..... \$9.95

If direct current is available instead of alternating current, all American Flyer trains should be run with an inverter in series which changes direct to alternating current and permits use of transformer and all other A. C. accessories with trains, such as directional control, crossing gate, etc. Full instructions with each inverter. Extra inverter fuses (No. 541) are \$.15 apiece.



**NEW** NEVER-FAIL AUTOMATIC COUPLERS AND  
REMOTE-CONTROL ELECTRICAL UNCOUPLER

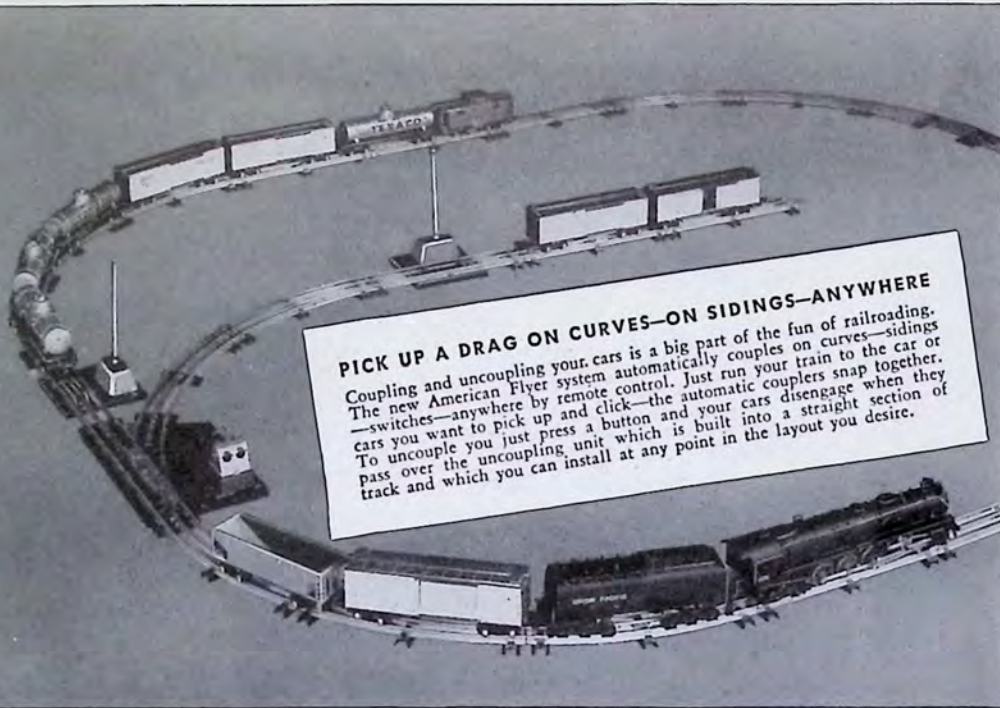

**PICK UP A DRAG ON CURVES—ON SIDINGS—ANYWHERE**

Coupling and uncoupling your cars is a big part of the fun of railroading. The new American Flyer system automatically couples on curves—sidings—switches—anywhere by remote control. Just run your train to the car or cars you want to pick up and click—the automatic couplers snap together. To uncouple you just press a button and your cars disengage when they pass over the uncoupling unit which is built into a straight section of track and which you can install at any point in the layout you desire.

**NEW** REMOTE CONTROL CROSS-OVERS MAKE  
SPECTACULAR RAILROAD DRAMA



SEE TRAINS DASH IN FRONT OF  
EACH OTHER AT CROSSOVERS

YOU PREVENT COLLISIONS  
BY REMOTE CONTROL

**ADDS NEW EXCITING ACTION TO YOUR LAYOUT**  
Two high speed trains are surging over the rails. The crossover towards which both are rushing is just ahead. Every eye is riveted on the scene. Every nerve is tense. But as an expert American Flyer railroad man, you know how to avert catastrophe. Calmly you touch one of your remote control buttons. One train comes to a quick stop while the other storms safely by.

**No. 675  
REMOTE  
CONTROL  
ELECTRICAL  
UNCOUPLER  
\$2.50**

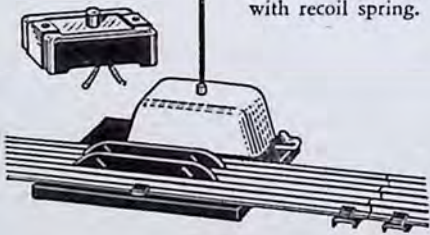

New type remote control uncoupler is built into 10" straight track section. Operates only with new style American Flyer automatic couplers. Complete with electric control button.

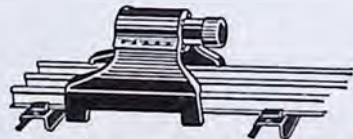

**No. 610 BUMPER . . . . . \$1.00**  
Complete with standard section of straight track. Easily snapped on and off. Equipped with recoil spring.



**No. 677 AUTOMATIC  
TRACK TRIP . . . . . \$ .35**  
Fits into straight track section, completes circuit as train passes. Operates gate signals or other automatic equipment.

**No. 676 AUTOMATIC COUPLERS . . . per pair \$ .75**  
Fine for converting cars with old style couplers to new automatic positive action type. Old wheels and axle spring easily into the new truck housing. Sold only in pairs.



**No. 450 Track  
Terminal . \$20**

**No. 413 12 Steel  
Track Pins . \$15**

**No. 414 4 Fibre  
Track Pins . \$15**

**No. 604 REMOTE CONTROL—90° CROSSOVER  
With Control Button . . . . . \$3.00**

The remote control crossover, No. 604, including double button control box, enables you to operate two trains on crossing tracks so as to avoid collisions. Whenever trains approach crossover at same time, you simply push a control button stopping one train until the other is safely past. A typical track layout showing use for No. 604 is diagram 1 on page 32.

**No. 602 CROSSOVER  
Without Control Button . . . . . \$1.25**

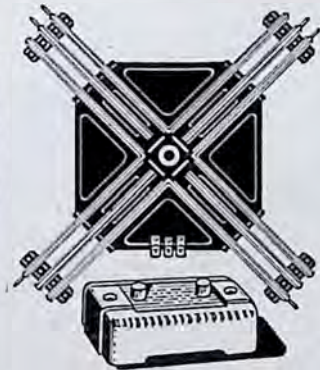

**"O" GAUGE TRACKS—40" DIAMETER**



**No. 680 Curve Track—10" long.....\$20**

**No. 622 1/2 Curve Track—5" long.....\$20**

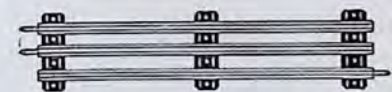

**No. 681 Straight Track—10" long.....\$20**

**No. 621 1/2 Straight Track—5" long.....\$20**

# New Double-Action Remote Control Switches ★

A SENSATIONAL-EXCLUSIVE  
AMERICAN FLYER DEVELOPMENT

## Make one train roar around the track - while keeping another train idle on the siding -

Perhaps you've seen pictures of a modern railroad control room. Here—keeping an eagle eye on the maze of tracks around him, a cool headed tower-man throws switches (or "bends the iron" in his language) as first one train and then another demands the right of way.

Today with American Flyer Double Action Remote Control Switches you, too, can perform similar feats of wizardry. By throwing switches at the right moment . . . stopping one train . . . starting another, you can make spectators gasp with wonder at your skill.

For example: A DeLuxe Express is hitting the curves on the main line. A freight on a siding is getting under way. The switch ahead is open. A collision seems certain!

But you're on your toes. You know your job. With switch control lever you close the open switch automatically stopping the freight and the express whizzes by.

Then as soon as the main line is clear, you open your switch—start your freight and see it roll majestically on its way.

Readily set for conventional operation or for dead siding.

Inventions such as this make American Flyer trains the choice of boys who want all the thrills that railroading provides.

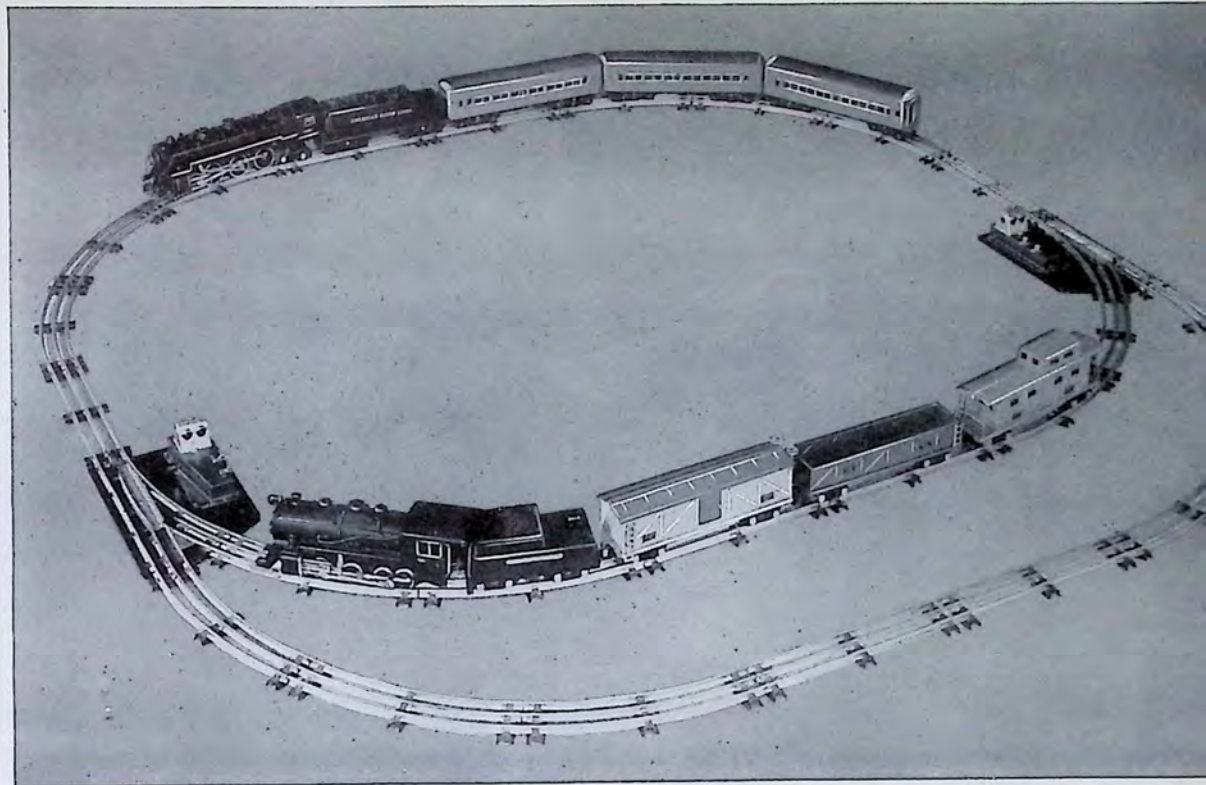

**No. 688 PAIR "O" GAUGE SWITCHES (Remote Control)**  
Quick action electric switches with red and green lights and remote control box with two switch control levers . . . . . **per pair \$7.95**



**No. 665—Pair "O" GAUGE SWITCHES (Manual Control)**  
**per pair \$3.00**

Similar in construction to the electric switches, but operated by hand. No lights included with this pair of switches.

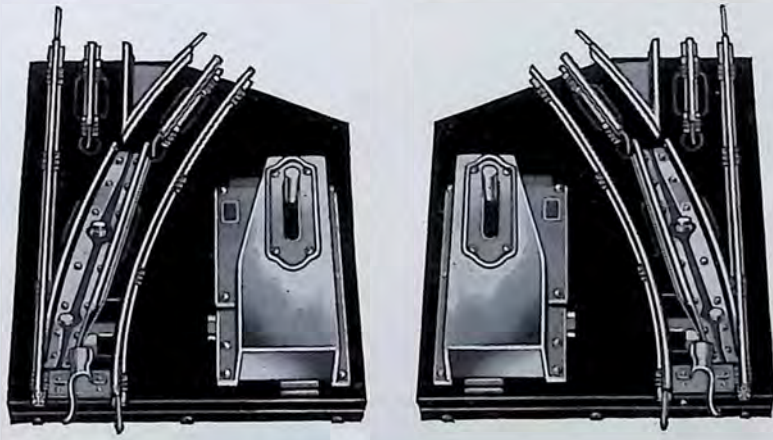

WHOO-WHOO-OO



No. 490 WHISTLING EXPRESS CAR  
(Remote Control) \$4.95

Here's a big double value—a realistic whistle and a 3/16" scale model express car that can be used on both passenger and freight trains. This car is the newest development in *direct from train* whistling. You can sound the whistle any time and anywhere with the remote control push button. This Whistling Express Car cannot be used in connection with Directional Remote Control Trains or with trains operating on 25 cycles or on D.C. except with use of No. 10 D.C. Inverter. When you have any of these conditions, use the billboard described below.

"CHOO CHOO" TENDERS  
HEAR 'EM!

Bring your present American Flyer 3/16" scale model trains up-to-date by adding one of these new tenders with built-in "Choo-Choo," miniature railroad's latest and newest sound device. Purchased separately and easily added to your present equipment. 5 units to choose from with "Choo-Choo" built into tender that is correctly designed for the train you now own. Get one today—they make electric trains sound like real ones.

No. 577 WHISTLING BILLBOARD  
(Remote or Automatic Control) \$2.50  
INCLUDING AUTOMATIC TRACK TRIP  
AND SIGNAL BUTTON CONTROL BOX

Whoo-oo-oo! What a realistic and startling sound every time your train passes over the automatic track trip. Or you blow the danger whistle any time you want by pressing the control button. Whistle can be operated with Directional Remote Control. Operates on 25 or 60 cycles, A.C. or D.C.

No. 555C  
B & O  
TENDER  
WITH  
"CHOO-CHOO"  
\$5.50



No. 564C  
ATLANTIC  
TENDER  
WITH  
"CHOO-CHOO"  
\$5.50



No. 558C  
PENN.  
TENDER  
WITH  
"CHOO-CHOO"  
\$6.50



No. 563C  
HUDSON  
TENDER  
WITH  
"CHOO-CHOO"  
\$7.50



No. 567C  
UNION  
PACIFIC  
TENDER  
WITH  
"CHOO-CHOO"  
\$8.50



THEY MAKE THE  
*Music*  
OF THE IRON PIKE

WHOOO-WHOOO



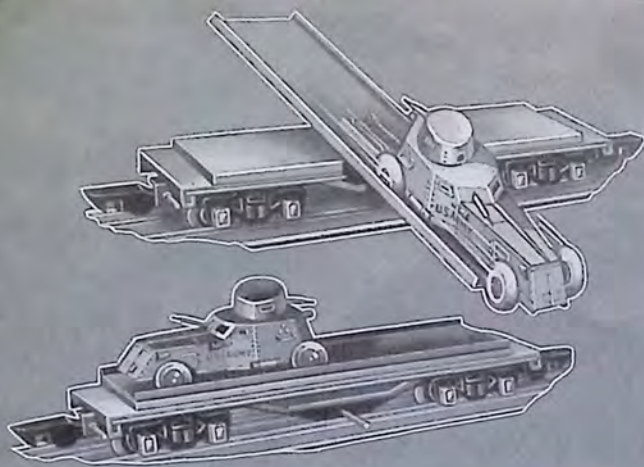

**No. 472 AUTOMATIC ARMY UNLOADING CAR . . . \$3.95**

(INCLUDES AUTOMATIC TRACK TRIP AND SINGLE BUTTON CONTROL BOX)

These are the days when Uncle Sam is motorizing cavalry . . . and American Flyer develops the first unloading car for rapid-fire handling of an armored truck. Just press the remote control button and automatically the platform on the car swivels, tilts and shoots the armored truck down the incline. Car brilliantly colored in enamel finish.  $7\frac{3}{8}$ " long.

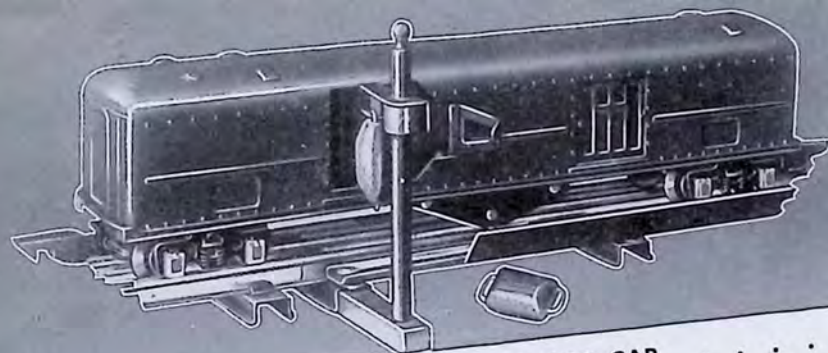

**No. 492 MAIL PICK-UP AND DISCHARGING CAR . . . . . \$3.95**  
(INCLUDES SPECIAL TRACK SECTION AND SINGLE BUTTON CONTROL BOX)

In goes one mail bag, out pops another as mail car speeds over the special section of track. Just press a remote control button and automatically the metal pick-up arm on the car is extended picking up one bag as another is ejected. Lots of action. Mail car finished in Pullman green,  $10\frac{3}{4}$ " long.

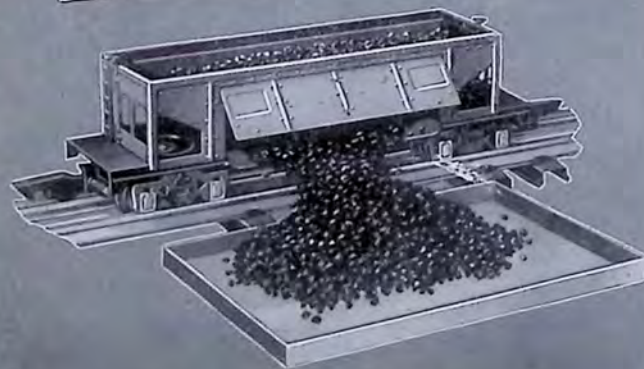

**No. 474 AUTOMATIC DUMP CAR . . . . . \$3.95**

(INCLUDES AUTOMATIC TRACK TRIP, COAL BIN, AND SINGLE BUTTON CONTROL BOX)

Press a remote control button, the side of the car swings open, and the coal pours out into the unloading bin. You can do what every railroad wishes it could—unload freight automatically where and when you wish by electricity. Car  $7\frac{3}{8}$ " long.



**Left—No. 494 BAGGAGE CAR . . . . . \$2.75**

Double truck, nickel journal boxes, 8 wheels. These fine baggage cars are finished in red, blue or tuscan electrically baked enamel. Car  $10\frac{3}{4}$ " long.

Right—

**No. 495L COACH (with light) \$3.00**

**No. 495 COACH (without light) \$2.75**

Both types finished in red, green or tuscan; No. 495 also in blue. Double truck, nickel journal boxes, 8 wheels. Car  $10\frac{3}{4}$ " long.



ADD A CAR  
A MONTH



ADD A CAR  
A MONTH



ADD A CAR  
A MONTH



**AUTOMATIC ACTION CARS**  
*and other  $\frac{3}{16}$ " Scale Model*  
*Pressed Steel Cars*



ADD A CAR  
A MONTH



ADD A CAR  
A MONTH



ADD A CAR  
A MONTH

**Right—No. 496L PULLMAN CAR (with light) . . . . . \$3.25**

Like real Pullmans even to imitation shades in window. Double truck, nickel journal boxes, 12 wheels. Finished in red, green or tuscan electrically baked enamel. Car  $10\frac{3}{4}$ " long.



**Left—No. 497L OBSERVATION CAR (with light) \$3.50**

Sturdy and sleek—double truck, nickel journal boxes, 12 wheels. Imitation shades in window. Car has observation platform. Finished in red, green or tuscan electrically baked enamel. Car  $10\frac{3}{4}$ " long.



No. 476 GONDOLA CAR . . . . . \$2.00  
Pressed Steel. Sturdily built with brake wheel. 7 7/8" long.



No. 512 TANK CAR . . . . . \$4.00  
Die-cast, rails, ladder, simulated filler cap. Car 7 1/2" long.

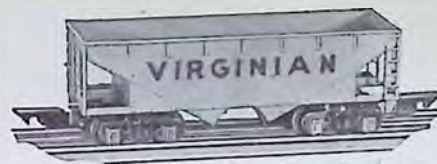

No. 508 HOPPER CAR . . . . . \$4.00  
Die-cast, nickel journal boxes, ladder. Car 6 1/2" long.



No. 482 LOG CAR . . . . . \$2.00  
Pressed Steel. Six realistic logs and brake wheel. 7 7/8" long.



No. 483 GIRDER CAR . . . . . \$2.00  
Pressed Steel. Loaded with bridge girder. Has brake wheel, 7 7/8" long.



No. 486 HOPPER CAR . . . . . \$2.00  
Pressed Steel. Ladders, brake wheel and manual control lever. 6 1/2" long.



No. 480 TANK CAR . . . . . \$2.00  
Pressed Steel. Ladders, hand rail and brake wheel. 7 7/8" long.

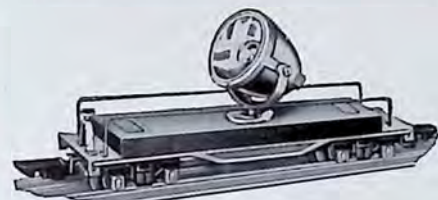

No. 488 FLOODLIGHT CAR . . . . . \$3.00  
Pressed Steel. Light turns and tilts on swivel base. 7 7/8" long.



No. 504 GONDOLA CAR . . . . . \$4.00  
Die-cast, nickel journal boxes, brake wheel. Car 7 1/2" long.

## 3/16" SCALE MODEL ROLLING STOCK

*to give your railroad resplendent realism*



Designed from actual railroad blueprints, these fine pressed steel and die-cast cars are correctly scaled to the most minute detail by painstaking American Flyer engineers. Brake wheels, ladders, journal boxes and even rivet heads are exact miniatures of the real thing. All cars are equipped with automatic couplers. Make a list of the cars you need, then add a new car every month. Cars finished in vivid colored enamel.



No. 478 BOX CAR . . . . . \$2.00  
Pressed Steel. Sliding doors, ladder and brake wheel. 7 7/8" long.



No. 516 CABOOSE . . . . . \$4.50  
Die-cast. Illuminated. Nickel journal boxes. Car 6" long.



No. 521 BAGGAGE AND CLUB CAR . . . . . \$5.50  
Die-cast. Illuminated. Sliding and hinged doors. 12 wheels. Car 12" long. Finished in green.



No. 524 PULLMAN CAR . . . . . \$5.50  
Die-cast. Illuminated. Hinged doors. Car 12" long. Finished in green.



No. 484 CABOOSE (with light) . . . . . \$2.00  
Pressed Steel. Cupola, end rails, ladders. 6 1/2" long.



No. 514 WRECKER CAR . . . . . \$5.00  
Die-cast. Cab and boom turn on swivel. Boom and hook raises and lowers. Car 7 1/2" long.



No. 506 BOX CAR . . . . . \$4.00  
Die-cast, sliding doors, ladder. Car 7 1/2" long.



No. 510 CATTLE CAR . . . . . \$4.00  
Die-cast, sliding door, brake wheel, ladder. Car 7 1/2" long.

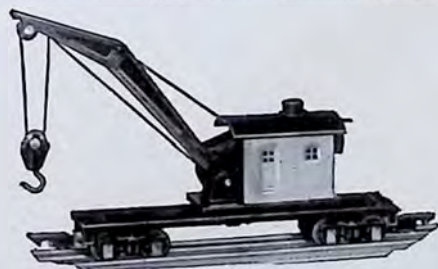

No. 481 WRECKER . . . . . \$3.50  
Pressed Steel. Cab and boom turns on swivel base. Boom and hook raises and lowers. 7 7/8" long.

# Make Trains STOP and GO automatically as Lights flash Red and Green

YOUR CHOICE OF SEARCHLIGHT OR SEMAPHORE BLOCK SIGNAL SYSTEM

Make "Safety First" the watchword of your American Flyer system by installing a new Searchlight or Semaphore Block Signal System to operate your trains with true-to-railroading realism—and with the dazzling effects that lighting creates.

Look at the pictures below and see what happens. Two trains are racing around the single track. You see the rear train rapidly gaining on the first. Breathlessly you watch. Will there be a collision?

No! Your American Flyer signal system automatically

stops the second train and the signal light stays red until the first train has cleared the block.

But look again! Now the first train is out of the block. The red signal turns to green. The block is clear. The second train gathers speed and once more is storming down the main line.

When running one train you can make the lights flash red and green, you can raise and lower the semaphore arm—all by remote control . . . letting the block signals or the semaphore signals stop and start your train.

NOTE: ON TRAINS EQUIPPED WITH STANDARD REMOTE CONTROL, IT IS NECESSARY TO MANUALLY DISENGAGE THE CONTROL TO PERMIT THE TRAIN TO OPERATE AUTOMATICALLY WITH BLOCK SIGNALS AND OTHER TRAIN CONTROLLING EQUIPMENT.

## Get the Thrill of Highballing Two Trains on the Same Track without danger of collision

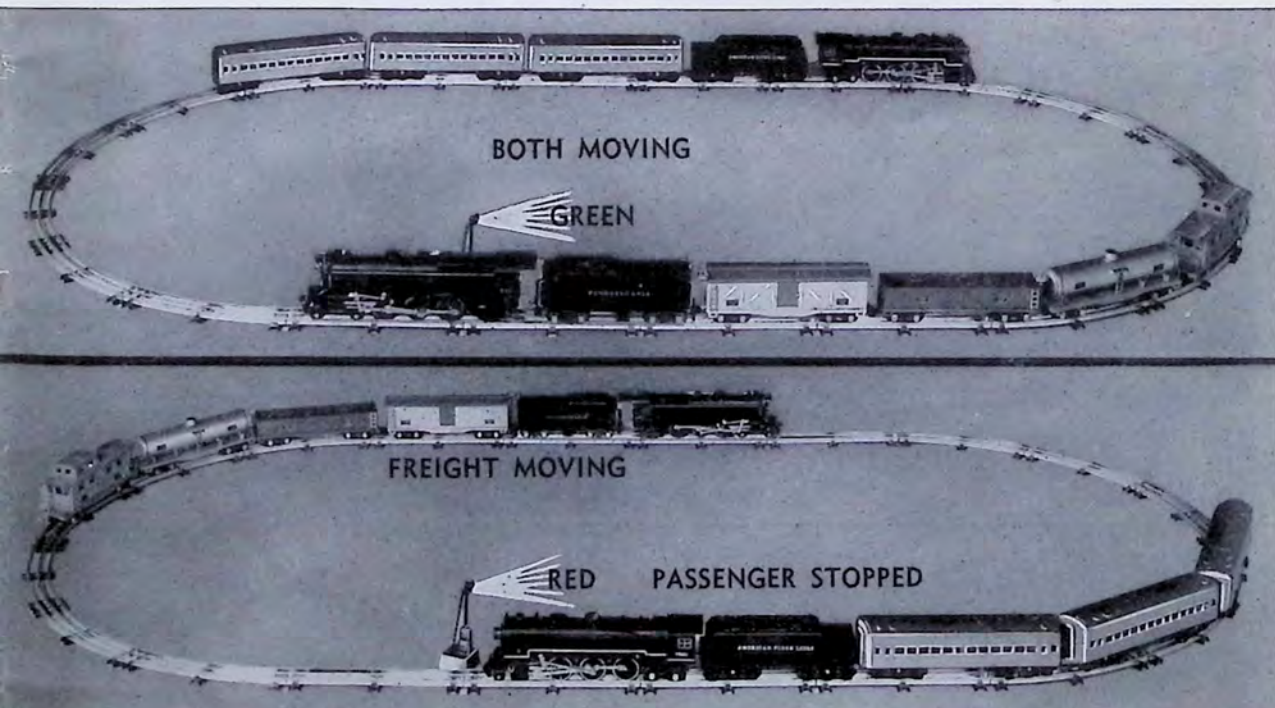

No. 587 AUTOMATIC  
BLDCK SIGNAL \$3.95

(WITH TWO AUTOMATIC TRACK  
TRIPS AND REMOTE  
CONTROL BOX)

Searchlight type. Operated like a real signal system. Permits one train to follow another on single track without danger of collision. Light flashes red and green. Electrically operated by remote control for one train. Two train operation works automatically from trips in track. Enamel finish. Size  $5\frac{1}{2}''$  high, base  $1\frac{1}{4}'' \times 1\frac{1}{4}''$ .

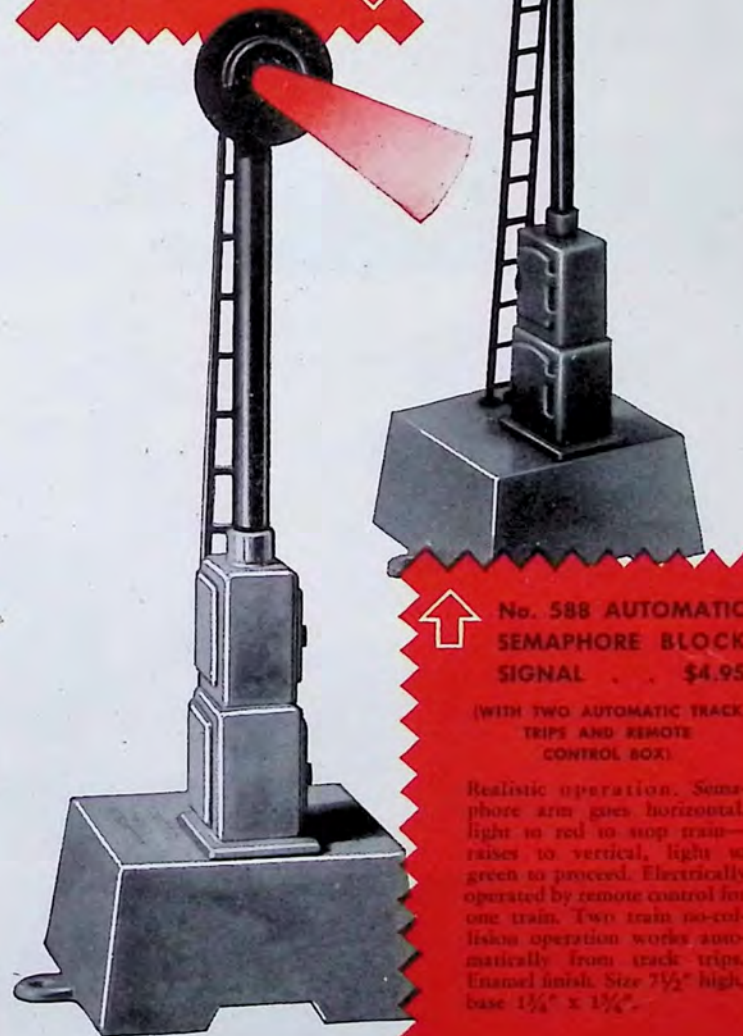

No. 588 AUTOMATIC  
SEMAPHORE BLOCK  
SIGNAL \$4.95

(WITH TWO AUTOMATIC TRACK  
TRIPS AND REMOTE  
CONTROL BOX)

Realistic operation. Semaphore arm goes horizontal, light is red to stop train—raises to vertical, light is green to proceed. Electrically operated by remote control for one train. Two train no-collision operation works automatically from track trips. Enamel finish. Size  $7\frac{1}{2}''$  high, base  $1\frac{1}{4}'' \times 1\frac{1}{4}''$ .

# "O" GAUGE EQUIPMENT . . . EVERY PIECE ACCURATELY BUILT TO

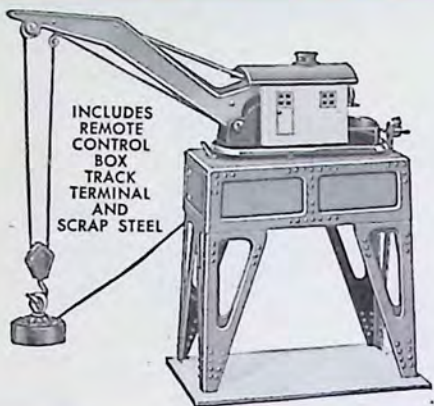

**No. 583 ELECTROMATIC CRANE . . . \$4.95**

Crane up load of steel with powerful electro-magnetic swivel over car and unloads—all by remote control. Size 11" x 8" x 6".



**No. 597 a-KOOSTIKIN PASSENGER AND FREIGHT STATION . . . \$9.95**

**Including Automatic Track Trip**

Most realistic and thrilling station ever invented—exclusive with American Flyer. Produces exciting true-to-life sounds. Automatically stops and starts your train. Enamel finish. Size 6" x 11" x 8".



**No. 584 BELL DANGER SIGNAL . . . \$3.95**

**(With Automatic Track Trip)**

Large blinking signal and sharp warning bell that rings as trains pass by. Complete with watchman. Brilliant enamel finish. Size 10" x 3 1/4".



**No. 589 PASSENGER AND FREIGHT STATION . . . \$3.95**

**(Includes Track Terminal)**

Big passenger station with realistic windows, swinging door and interior illumination. Size 6" x 12" x 8".

**No. 598 Extra a-Koostikin Record \$ .35**

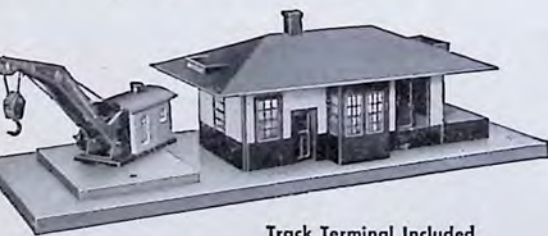

**Track Terminal Included**

**No. 612 FREIGHT AND PASSENGER STATION WITH CRANE . . . \$4.95**

Combination station and revolving crane. Regulation passenger section with ticket office, windows, door and interior illumination. Freight section has raised loading platform and two sliding doors. Equipped with hand operated crane. Cab and boom mounted on swivel base permitting complete revolution. Boom with hook raises and lowers. Brilliant coloring. Size 10" x 8" x 5 1/2".

**No. 596 WATER TANK \$3.95**

**Includes Track Terminal and Push Button**

You lower and raise water spout by remote control. Has ladder. Aviation warning light on top of tank. Size 11" x 6" x 6 1/2".



**No. 595 a-KOOSTIKIN TALKING TOOL SHED . \$6.95**

**Includes Automatic Track Trip**

Produces the sound effects of real railroading. Stops and starts your train automatically. Size 4 1/2" x 6 3/4" x 3 1/4".

**No. 585 TOOL SHED—\$1.25**



**No. 594 TRACK GANG SET (Animated) . . . \$4.95**

As train approaches, flagman moves forward, tamper moves back, stop work. After train passes, men automatically start work again. Electrically operated with shut-off switch. Brilliant enamel finish. 10" x 3 3/4" x 2 1/2".

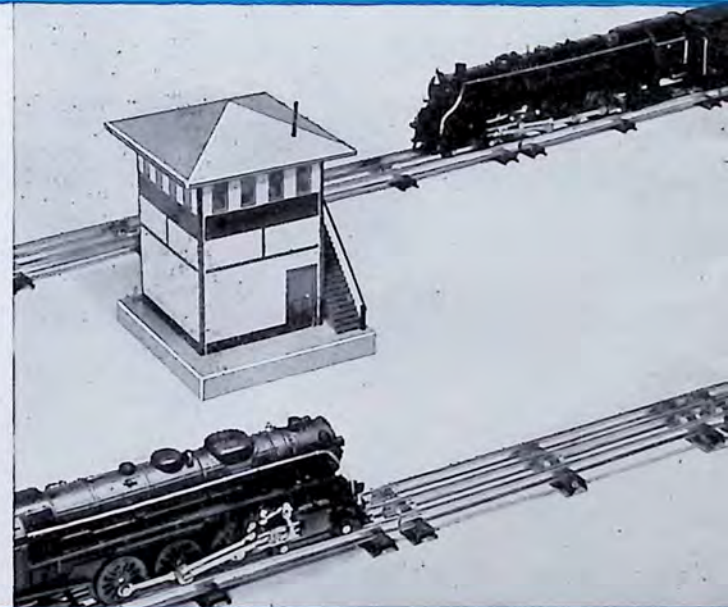

**No. 593 SIGNAL TOWER (with track terminal) . . . \$2.95**

Stairs lead up to lighted operator's room on second floor. Windows on three sides. Brilliantly colored enamel finish. Size 7 3/8" x 3 1/2".

# "O" GAUGE SCALE! *Take a tip from experts on miniature railroading*

Don't buy equipment just for  
bigness - BUY FOR SCALE!

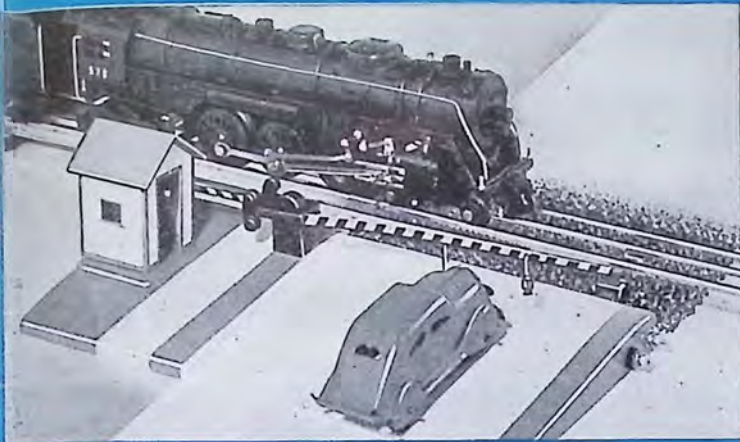

**No. 591 CROSSING GATE WITH WATCHMAN'S SHACK** . . . . . \$3.95  
Your speeding train automatically controls the raising and lowering of double arm gates. Red light shines when gate is down. Die-cast. Enamel finish. Size 10" x 3 1/4".

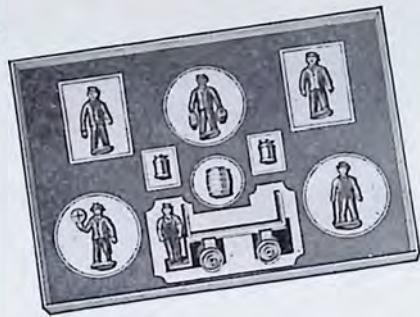

**No. 578 STATION FIGURE SET** . . . \$1.50  
6 hand painted workers, platform truck, 2 milk cans and 1 barrel. Add realism to railroad scenes.

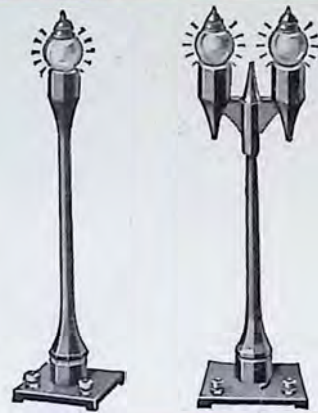

**No. 579 STREET LIGHT (with track terminal)** . . . . . \$1.25  
Modern design with frosted bulb. Electrical contact through terminals in sturdy base.

**No. 580 DOUBLE ARC LIGHT** . . . . . \$1.95  
(Includes track terminal)  
Makes night operation more spectacular. Frosted bulbs. Sturdy base. Baked enamel finish. Size 6 1/2" x 1 1/2".

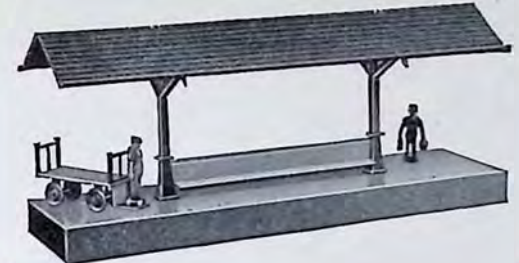

**No. 586F WAYSIDE STATION (with figures)** . . . \$2.00  
Smart new suburban station with baggage track, operator and porter. Double bench, long roof and two lights. Enamel finish. Size 12" x 9" x 3 3/4".

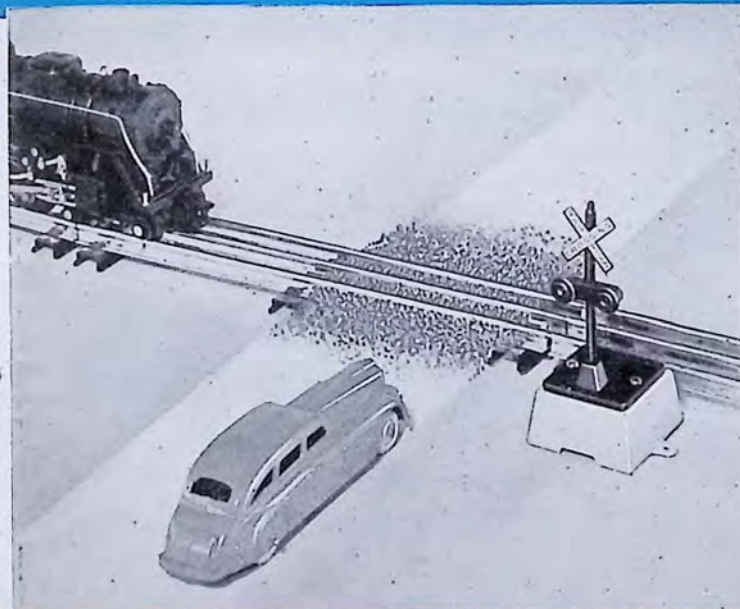

**No. 582 AUTOMATIC BLINKER SIGNAL** . . . . . \$1.95  
(With Automatic Track Trip)  
Double bull's eye Lucite blinkers flash red automatically as train passes. Mounted on sturdy base. Enamel finish. Size 4 1/8" x 2 3/8" x 2 3/16".

**WHOO-WHOO  
WHOO**



**No. 577 WHISTLING BILLBOARD (Remote or Automatic Control)**  
Includes Automatic Track Trip and Signal Control Box  
Whistles anytime by remote control or automatically through a track trip. Illuminated. Size 4" x 7 1/2" x 4". . . . \$2.50

**BULBS—ALWAYS HAVE EXTRAS ON HAND**  
Lamps are used as follows: No. 440 in all Locomotives and cars, all stations and equipment except No. 579 and 580. No. 451 for No. 579 and No. 580 Lamp posts. No. 441 where red globes are required. No. 443 where green globes are required. No. 452 for No. 588 Semaphore.

No.	Volts	Glass	Color	Diam.	Lamps in Pkg.	Price
440	14	Round	Clear	7/16"	3	\$ .25
441	14	Round	Red	5/8"	3	.25
443	14	Round	Green	5/8"	3	.25
451	14	Round	Frosted	5/8"	1	.25
452	14	Min. Round	Clear	5/16"	1	1.00

**No. 581 GIRDER BRIDGE** . . . \$2.00  
Sturdy, strong, modern girder type. Slips under any straight track section. Black finish. Size 10" x 1 3/4" x 4 5/8".



**No. 611 TRESTLE BRIDGE** . . . \$2.50  
(Includes Track Terminal)  
Built of heavy steel. Tenders house with interior light or top. Bright enamel finish. Size 17 3/4" x 8 1/4" x 4 1/2".



**"O" GAUGE TUNNELS**  
No. 247—11" Straight . . . \$1.00  
No. 248—14" Straight . . . \$2.00

## "HO" GAUGE THE HOBBYISTS' LINE



# Gilbert AMERICAN FLYER TRU-MODEL "HO" TRAINS

Not only do these "HO" trains represent the utmost in realism, but their small size enables you to have elaborate and exciting track layouts in extremely small space. An especially notable achievement is the 2-rail track, eliminating a center rail. Brass wheels on opposite tender trucks act as current collectors—while all other wheels are of Bakelite. Drive wheels have metal rims. 20 to 1 gear reduction assures amazing pulling power. Actual stop watch tests show these matchless trains can attain a speed of 190 scale miles per hour. While these "HO" trains are built to hobbyists' precision standards, their modest price puts them within the reach of all to whom miniature railroading is an ever-thrilling adventure.

**PRIDE OF HOBBYISTS  
BUILT TO SCALE FROM RAILROAD  
BLUEPRINTS - CORRECT IN EVERY  
DETAIL - REALISTIC "2 RAIL" TRACK  
MOUNTED ON BAKELITE ROADBED**

Note: Directional Remote Control on Trains HO-103, HO-104 and HO-105 will not operate on D.C. where a reducer is used. The No. 10 D.C. Inverter will have to be used to operate these trains on Direct Current. Will not operate on 25 cycles.



75 or 100 Watt Transformer recommended

### HO-103 3 CAR "HOT SHOT" FREIGHT TRAIN—31" LONG . . . \$21.95 Directional Remote Control—Automatic Coupling

A marvel of tru-model design and precision construction, this 14" die-cast directional remote control N. Y. C. Hudson type locomotive, with its tender and cars surges over the iron. Beaming Lucite headlight and eccentric arms, valve levers and piston rods that shuttle back and forth with gleaming realism. Each of the die cast cars has automatic couplers.

Complete HO-103 Train set consists of: 1 HO-112 Locomotive and Tender, 14" long; 1 HO-117 "Lehigh N. E." Gondola with metalescent finish; 1 HO-114 "Merchants Despatch" Car, white and tuscan red; 1 HO-120 Caboose with cupola, end rails and ladders; 12 8 3/8" sections HO-260 curved track (makes 100" circle); Track Terminal and Control Box.

HO-103 TRAIN SET . . . \$21.95



75 or 100 Watt Transformer recommended

### HO-104 3 CAR "HOT SHOT" PASSENGER TRAIN—42" LONG . . . \$24.95 Directional Remote Control—Automatic Coupling

Thrilling Tru-Model passenger train. Same fine die-cast directional remote control locomotive that's made American Flyer "HO" trains famous. 9" cars, with automatic couplers. Bakelite wheels. Cars finished in green baked enamel.

Complete HO-104 Train set consists of: 1 HO-112 N. Y. C. Hudson type (4-6-4) Locomotive and Tender, 14" long; 1 HO-121 Baggage and Mail Car; 2 HO-122 Passenger coaches; 12 8 3/8" sections HO-260 curve track. Realistic Bakelite Roadbed (makes 100" circle—32" diameter); Track Terminal and Control Box.

HO-104 TRAIN SET . . . \$24.95



75 or 100 Watt Transformer recommended

### HO-105 7 CAR TRANSCONTINENTAL RED BALL—56 1/2" LONG . . . \$26.95 Directional Remote Control—Automatic Coupling

The glory of "HO" railroading combining authentic appearance with breath taking performance this 7 car "Red Ball" deserves its reputation as the finest value miniature train ever offered to boys or grown-up hobbyists.

Complete HO-105 Train set consists of: 1 HO-112 N. Y. C. Hudson type (4-6-4) Locomotive and Tender, 14" long; 1 HO-113 "Pacific Fruit Express" Ref. Car, Tuscan red with yellow sides, ladder and cat walk. 1 HO-118 "P. R. R." Gondola, Tuscan red with white lettering; 1 HO-114 "Merchants Despatch" Ref. Car, Tuscan red, white sides, ladder and catwalk; 1 HO-116 "Sinclair" Tank Car, Black tank, white lettering; 1 HO-115 "Texaco" Tank Car, Silver tank, black lettering; 1 HO-119 "Ill. Central" Flat Car, loaded with three trucks and wheels; 1 HO-120 Caboose with cupola, end rails and ladders; 12 8 3/8" sections HO-260 curve, 2 8" sections HO-261 straight (makes 116" oval); Track Terminal and Control Box.

HO-105 TRAIN SET . . . \$26.95

ADD A SECOND ENGINE  
MORE CARS TO YOUR  
LINE AND DOUBLE  
YOUR FUN!

*Build 'em Yourself  
if you like*

Build 'Em yourself — Miniature Tru-Model Locomotives and Rolling Stock in ready-to-assemble kits.

Building these realistic "HO" gauge Tru-Model locomotives, tenders and cars is nearly as much fun as running them afterwards. Actually to see a model of a true-to-life locomotive take shape in your own hands—as you add one part after another—gives you a glorious sense of achievement. And you don't have to be an expert craftsman to follow the easy instructions.

Kits are complete with die cast parts, automatic couplers, paints, brushes, decalcomanias — everything you'll need to build a model that will make you the envy of all your friends. Every section of every locomotive, tender and car is machined, drilled and tapped with flawless precision. No filing or scraping is necessary to make them fit perfectly. Get yourself an "extra bonus" in fun and enjoyment by making your own "HO" train — look over these splendid kits now and decide which ones you want first.

"HO" GAUGE  
THE HOBBYISTS' LINE

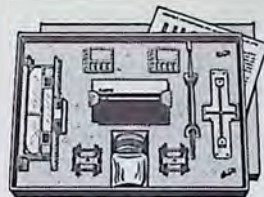

**HO-120K CABOOSE . \$1.75**  
This fascinating kit builds an authentic perfectly scaled caboose. Everything you need from start to finish is included along with easy-to-follow instructions.

**HO-120 CABOOSE . \$2.25**  
4½" long. Perfectly scaled. Cupola, end rails and ladders. Die-cast. 8 Bakelite wheels.

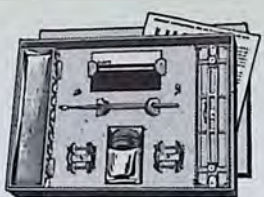

**HO-117K "L.N.E." GONDOLA KIT and HO-118K "PENN" GONDOLA KIT . ea. \$1.75**  
You'll want to build both these gondola cars. Each kit contains automatic couplers, paints and brushes.

**HO-117 GONDOLA CAR \$2.25**  
"Lehigh New England" 5¼" Gondola. Metalescent finish, white lettering.

**HO-118 GONDOLA CAR \$2.25**  
"Pennsylvania" 5¼" Gondola. Tuscan red, white markings.

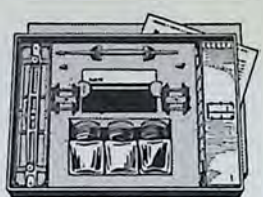

**HO-113K "PAC. FRUIT EXP." HO-114K "MERCHANTS DES." REFRIG. CAR KITS . ea. \$1.75**  
Die-cast sections, trucks, bakelite wheels, automatic couplers, paint. Everything to build a fine refrigerator car.

**HO-113 "PACIFIC FRUIT EXP." 5¾" LONG . . . \$2.25**  
Tuscan Red finish, yellow sides.

**HO-114 "M. D." REF. CAR 5¾" LONG . . . \$2.25**  
Ladders, catwalk, white sides.

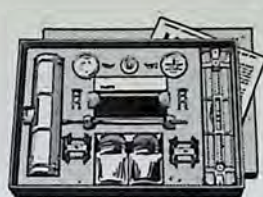
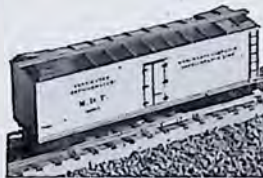

**HO-115K "TEXACO" TANK CAR KIT, HO-116K "SINCLAIR" CAR KIT . . . . . ea. \$1.75**  
Kits make Tank Cars which are exact replicas of those used by two of the major oil companies.

**HO-115 "TEXACO" TANK CAR—5¾" LONG . . \$2.25**  
Silver finish. Black lettering on side of tank car.

**HO-116 "SINCLAIR" TANK CAR—5¾" LONG . . \$2.25**  
Black, white letters.



**HO-119K "ILLINOIS CENTRAL" FLAT CAR KIT . . . \$1.75**  
This kit builds an "Ill. Cent." flat car that's right in every detail—with three trucks for load.

**HO-119 "ILLINOIS CENTRAL" FLAT CAR—5¾" LONG . \$2.25**  
Finished in black with white lettering, carrying three spare trucks for realism.

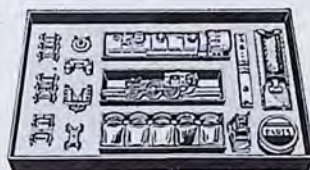

**HO-112K N.Y.C. (4-6-4) LOCOMOTIVE AND TENDER KIT . . . . . \$11.95**  
Armature, field, gears and drive wheels assembled to engine frame. Directional remote control unit included. Instructions, paints, brushes, etc. Operates on A.C. only. See page 42.

**HO-112 N.Y.C. (4-6-4) LOCOMOTIVE AND TENDER \$14.95**  
Die-cast, directional remote control, Lucite headlight, 6 huge drive wheels. Motor has 20 to 1 gear reduction. Operates on A.C. only. See page 42.

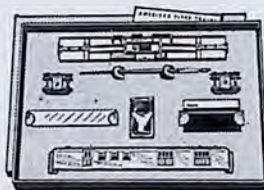

**HO-121K BAGGAGE AND MAIL CAR KIT . . . . . \$2.50**  
Builds authentic model of popular combination car. Automatic couplers and green enamel included.

**HO-121 BAGGAGE AND MAIL CAR—9" LONG . . . \$3.25**  
Die-cast, Tru-Model replica. Two 4 wheel trucks, automatic couplers, green enamel finish.

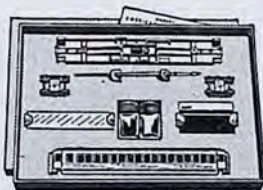

**HO-122K PASSENGER COACH KIT . . . . . \$2.50**  
Loads of fun to put together. Die-cast, automatic couplers, double trucks, paints, decals, etc.

**HO-122 PASSENGER COACH—9" LONG . . . . . \$3.25**  
Simulated glass windows, automatic couplers and finished in lustrous green enamel.



**HO-110K  
4 CAR FREIGHT  
TRAIN KIT \$16.95**

Builds N. Y. C. 4-6-4 Hudson type locomotive and tender, Refrigerator Car, Oil Car, Gondola and Caboose. Armature, field, gears and drive wheels assembled to engine frame. Directional remote control unit included. Instructions, paint, brushes, etc. Operates on A.C. only. See page 42.

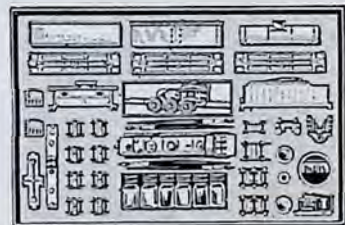

**HO-111K 3 CAR PASSENGER TRAIN KIT . . . . . \$16.95**

Builds N. Y. C. 4-6-4 Hudson type, locomotive and tender, Baggage and Mail car and two Passenger cars. Armature, field, gears and drive wheels assembled to engine frame. Directional remote control unit included. Bulb for headlight. Instructions, paints, brushes, etc. Operates on A.C. only. See page 42.

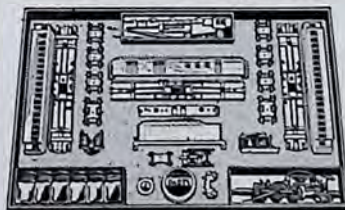

**"HO" GAUGE  
THE HOBBYISTS' LINE**

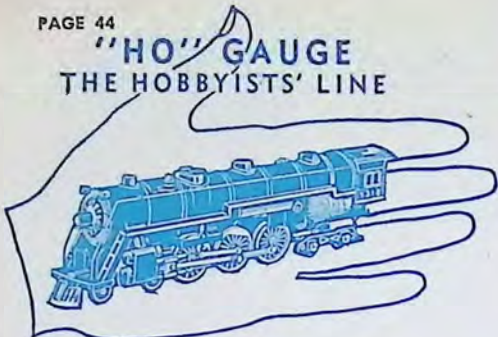

**"HO" TRU-MODEL EQUIPMENT  
makes your system look like  
A REAL RIGHT OF WAY**

Because of the high degree of skill and workmanship employed in the creation of "HO" Tru-Model equipment, prices have previously been necessarily high. Today, thanks to improved production methods of the Gilbert Hall of Science, high quality miniature equipment is now offered at popular prices. Vivid realism and exact authenticity is the keynote of each of the perfectly scaled models. When you select American Flyer Tru-Model equipment for your "HO" train, you'll own a miniature railroad system that is unsurpassed in correctness of design and perfection of finish.



**HO-258 PASSENGER AND FREIGHT STATION** \$2.95

Tru-Model illuminated station on raised platform with regulation bay window ticket office. Freight section has loading platform with sliding door.

**HO-254 GIRDER BRIDGE** . . . . . \$1.50



Modern plate girder type bridge authentically designed and built to correct scale dimensions. Finished in black and perfect in every detail.



**HO-252 BLOCK SIGNAL** \$3.95

Exactly scaled to the fine HO trains it controls, this ladder equipped signal is mounted on a rugged base. An electrically operated shutter turns light red or green.

**HO-12 TUNNEL** . . . \$1.00

Realistically colored and solidly constructed this mountain style 8" tunnel is a picturesque addition to your line. Correctly scaled.



**HO-256 SIGNAL TOWER** . . . \$2.95

Your HO roadway will have a new touch of realism when you add this brilliantly colored die-cast signal tower. Stairs lead up to lighted top floor.



**HO GAUGE SWITCHES**  
Sold in pairs only

**HO-265 MANUAL CONTROL TRACK SWITCHES**.....per pair \$5.00

Extra excitement is added to the fun of HO gauge railroading when you build the interesting track layouts these switches permit. 12 curve tracks form a 16" radius circle.

**HO-268 REMOTE CONTROL TRACK SWITCHES**.....per pair \$10.00

Equip your track layout with these fascinating remote control switches and trains obey your bidding as if by magic. The unique control box included with each pair of switches allows you to control them from a distant point. Red and Green lights on switches indicate in which direction they are set.

**2 RAIL TRACK**

Rails Mounted on  
Realistic Bakelite Roadbed

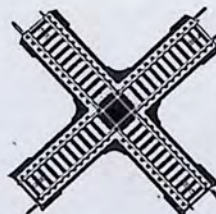

**HO-262 — 90° CROSSOVER** .....\$2.00

Two 8" straight track sections crossing at 90° angle make possible a variety of interesting layouts.



**HO-261 STRAIGHT TRACK**  
8" long .....\$ .40

**HO-263 1/2 SEC. STRAIGHT TRACK**—4" long.....\$ .40

Better plan to get enough sections of this type so you'll have an exciting "straightaway" in your track layout.

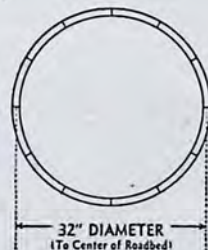

12 curve tracks form a 16" radius circle.



**HO-260 CURVED TRACK**  
8 3/8" long .....\$ .40

**HO-264 1/2 SEC. CURVED TRACK**—4 3/16" long.....\$ .40

Curved track is required to build the circle which is the basic track layout. All other layouts are elaborations of the circle. 12 sections make a 32" diameter circle.

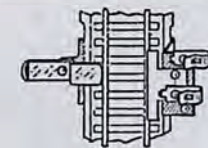

**HO-277 TRACK TRIP** .....\$ .50

Trip fits on straight section of track and completes circuit as train passes over. Operates signals or any automatic equipment.

**HO GAUGE TRACK LAYOUTS**

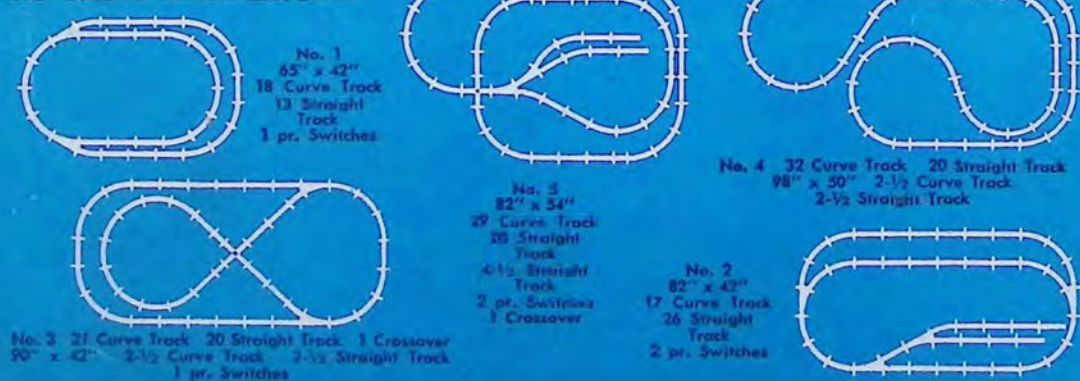



### DISCOVERED HOW TO WRITE MESSAGES IN INVISIBLE INK ON HIS ARM

This stunt brought Winfield Worth a big cash reward. With a strange chemical you cannot see, he writes a word on his bare arm. When he brushes over it with another Gilbert chemical, the word leaps out in a bright red color.



### WORKED OUT A CHEMICAL TRICK FOR CATCHING A SNEAK THIEF

Dean I. Walter won a cash reward by locating a locker thief at his school. A solution that turns dark when exposed to the light was so arranged as to spill on the culprit's hand. That gave the thief away.

## GILBERT CHEMISTRY SETS 10 REASONS WHY BOYS WHO WANT TO DO THINGS IN CHEMISTRY CHOOSE GILBERT LABORATORY SETS

# MORE BOYS HAVE WON FAME AND BIG AWARDS WITH GILBERT CHEMISTRY SETS THAN ANY OTHER CHEMISTRY SETS MADE

Boys, what is the real test of the "best" football team, baseball team, boxer or pole vaulter? You know the answer. It is the one that wins most frequently.

You can apply the same test when it comes to choosing the best chemistry set and when you do you'll say to Dad "I want a Gilbert Chemistry Set and nothing else but."

Because year after year more boys have won fame and big awards with Gilbert Chemistry Sets than any other kind. A record like that doesn't "just happen." It is proof that Gilbert Chemistry Sets are really better—that you can perform more exciting and realistic experiments with them—that they make possible more brilliant achievements in chemical research.

Read the true stories of what other Gilbert boy chemists have done. The door is wide open for you to do the same.

#### \$200.00 ANNUAL AWARDS

To the boy doing what, in my opinion, is the most important research in Chemistry, Microscopy or Electricity in 1942, I will award \$100.00 in cash. To the ten boys doing the next most important research, I will award \$10.00 each. Applicants must not be over 17 years old and must send me full description of their experiments by May 1st, 1942.

*A.C. Gilbert*

Founder of the Gilbert Hall of Science



### INVENTED SPECTACULAR "GREEN FAIRY FIRE"

A check for \$100.00 was Stanley Stewart's reward for developing his "Green Fairy Fire" experiment in his Gilbert Chemistry Laboratory. Take a tip from these successful boy chemists and get a set with "Gilbert" stamped on the box.



### WON \$50.00 FOR ORIGINAL EXPERIMENT

Here is Jack Carter in his Gilbert Chemical Laboratory working on some of the original experiments that brought him a check for \$50.00. Jack is an expert at making strange chemicals change color and form in mysterious ways.

- 1 Developed at the Gilbert Hall of Science, the world's largest institution devoted to bringing the wonders of modern science to modern boys.
- 2 Manuals written in clear boy language by Dr. Treat B. Johnson, Ph.B., Ph.D., famous Yale professor—author of over 300 articles on chemistry—and eminent authority on chemical research.
- 3 Far more than toy sets—because range of chemicals and apparatus are based on real laboratory technique.
- 4 All chemicals made to Gilbert Hall of Science quality standards.
- 5 Manual and chemicals for exciting and sensational experiments in inorganic chemistry—organic chemistry—and electro chemistry.
- 6 Chemicals in lightproof, non-breakable containers.
- 7 Glass-enclosed thermometer registers from 0 to 230° F.
- 8 Not just 1 manual but 4: Chemistry—Chemical Magic—Glass Blowing—Minerology.
- 9 Gas generator, mortar and pestle, beaker, test tube drying racks and other equipment scientifically designed for scientific research.
- 10 Bring you more colorful, more dramatic and more spectacular experiments—because sets have been constantly improved for 23 years.

# OPENING THIS BIG GILBERT CHEMISTRY LABORATORY is like opening the door to hundreds of Scientific Secrets

★  
**DOUBLE VALUE! DOUBLE FUN!** Spectacular  
 Experiments in both Chemistry and Glass Blowing

- REMEMBER, Gilbert Chemistry Sets are the choice of famous boy prize winners in chemical research. Big cash awards every year.

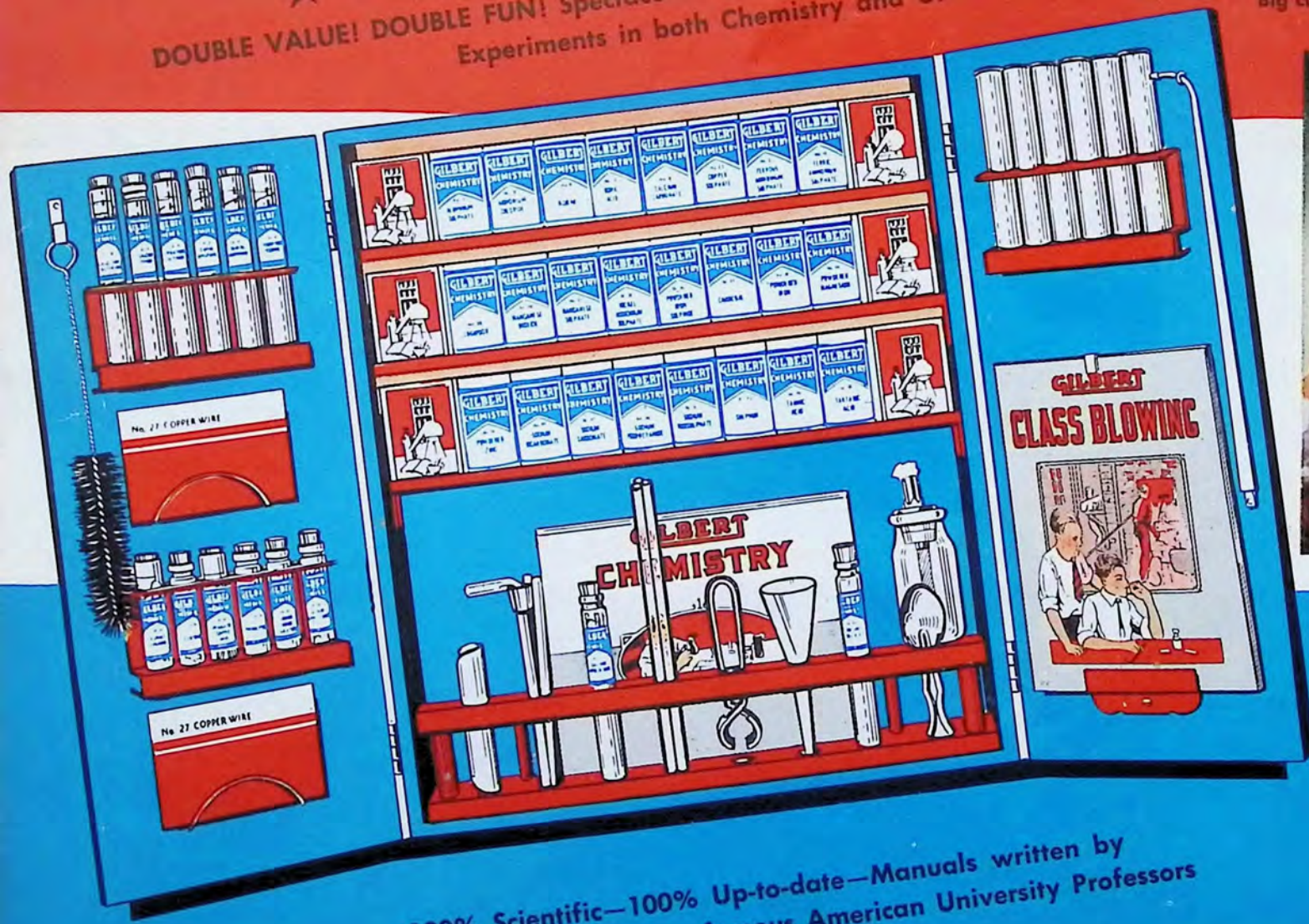

Courtesy of Monsanto Chemical Company, St. Louis, Mo.

100% Scientific—100% Up-to-date—Manuals written by  
 famous American University Professors

**Y**OU can tell by the vast array of chemicals and pieces of apparatus—by the real laboratory style racks and shelves, that this two-door big blue wooden cabinet is the latest word in truly scientific equipment. Generous supply of every chemical so that you can make lots of experiments. With this marvelous outfit you can write messages in fire ink, make a chemical weather flag, test a raisin for iron, turn a lemon into an electric cell, make your own paints, sparklers and soda water. A total of over 400 fascinating experiments are at your finger tips. Two manuals: one on chemistry and one on glass blowing. Price \$5.00.

# Conquer the Unseen Forces of Strange Chemicals with these Scientifically O. K. CHEMISTRY SETS



## No. 1 DANDY BEGINNER'S SET

Large supply of chemicals, and apparatus for performing colorful, exciting experiments. Fascinating manual shows how to perform 151 experiments. Priced so every boy can become a true Gilbert chemist. Price \$1.00



No. 2

**No. 2 JUNIOR CHEMISTRY LABORATORY**  
This sturdy blue wooden laboratory cabinet not only contains a generous supply of chemicals and glassware apparatus, but also has 18 inches of metal shelf space and test tube racks. Performs 131 experiments.

Price \$2.50

## No. 3 INTERMEDIATE CHEMISTRY LABORATORY

You've never seen one of the 343 spectacular and amazing experiments that this laboratory outfit puts at your finger tips. The manual by noted Yale professors tells you how to perform them with scientific realism. You have lots of elbow room, too—for the handy racks and shelves total a length of three feet. This two-door blue wooden cabinet is so crammed with chemicals and apparatus that it weighs over 4 pounds. Price \$3.50



No. 3

**AUTHENTIC LABORATORY TYPE EQUIPMENT  
NOT FOUND IN ORDINARY SETS . . .**



No. 10

NOT JUST  
1 MANUAL  
BUT  
3

GENUINE  
LABORATORY TYPE  
BALANCE  
SCALES

**THE ORIGINAL, COMPLETE, SCIENTIFIC, PROFESSIONAL-LIKE  
LABORATORIES—RECOGNIZED LEADERS FOR 25 YEARS**

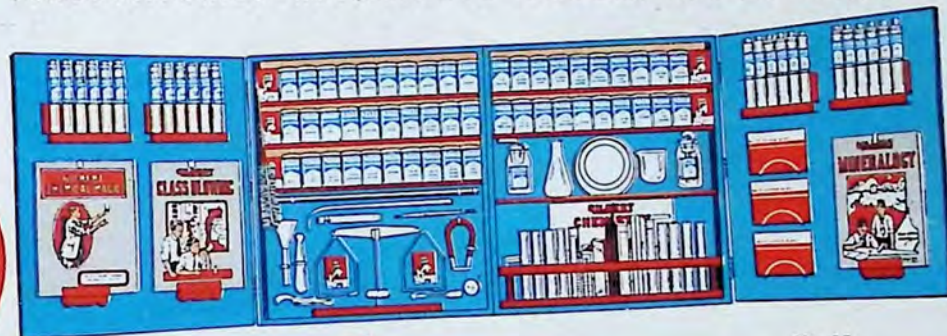

No. 15

## No. 10 INVENTOR'S CHEMISTRY LABORATORY

Typifying the high standards found only in sets developed by the Gilbert Hall of Science, this four-compartment wooden cabinet enables you to do boy-inventor's research in chemical magic, glass blowing and chemistry. The 600 experiments that you can perform go far beyond the limits of so-called "just as good" sets. They are more colorful, more dramatic, more scientific. The impressive array of chemicals and apparatus require 7½ feet of test tube racks and shelf room and give the outfit a total weight of 10 pounds.

Price \$10.00

**THE ONLY Chemistry Sets O. K.'d  
by The Gilbert Hall of Science  
and O. K.'d by America's  
Most Famous Boy Chemists**

**4  
BIG MANUALS  
BY NOTED  
AMERICAN  
SCIENTISTS**



## No. 15 MASTER SCIENTIST'S CHEMISTRY LABORATORY

When you own this mammoth chemistry set you can correctly feel you have the finest, most complete and most scientific outfit a boy can have. It takes you into such exciting and spectacular fields of research as experiments with dry-ice, artificial refrigeration, electro-chemistry, electro-plating, ethyl gas, electrolysis, mineralogy, chemical magic . . . experiments made easy for the first time by the quality of Gilbert chemicals and equipment and the four big, clearly written manuals. The range of listed experiments totals over 800—and you can perform an infinite number of original experiments of your own. Equipment includes vast array of chemicals, thermometer, scales, gas generator, alcohol lamp and numerous other gleaming pieces—all made to Gilbert Hall of Science quality standards. Over 9 feet of shelf room and test tube racks. Weighs 15 pounds. Price \$15.00

★ FOR TODAY'S FUN AND TOMORROW'S CAREER ★



Gilbert toys are different from ordinary toys. They are more fun... because every day you can do something new, interesting and exciting with them. They are more real... because they enable you to do now the bold, adventurous things you want to do when you grow up to be a man.

This is the age when the world's most thrilling adventures lie in the field of science—engineering, chemistry, electricity, microscopy and other forms of scientific activity. There is as much romance in discovering the secrets of strange chemicals as the secrets of strange lands. There is as much exciting fun in building a giant engineering marvel as in exploring a giant mountain. There is as much glory in conquering the wild forces of electricity as in conquering wild tribes.

Thus, the Gilbert Hall of Science brings you the all-electric Erector—the construction set that builds actual operating models of spectacular marvels of the machine age; Gilbert Polarizing Microscopes—the sets that reveal the wonders of nature's hidden colors; Gilbert Electrical Sets—chock full of fascinating fun and scientific wizardry; and other Gilbert scientific toys.

See all of the products of the Gilbert Hall of Science at your nearest department or toy store... tell Dad which ones you want most for Christmas... and get in on the fun of playing a leading part in the spectacular drama of modern science.

*A.C. Gilbert* FOUNDER OF THE  
GILBERT HALL OF SCIENCE

★ Ask for Toys from the GILBERT HALL OF SCIENCE ★