

— *the NEW* —

ERECTOR

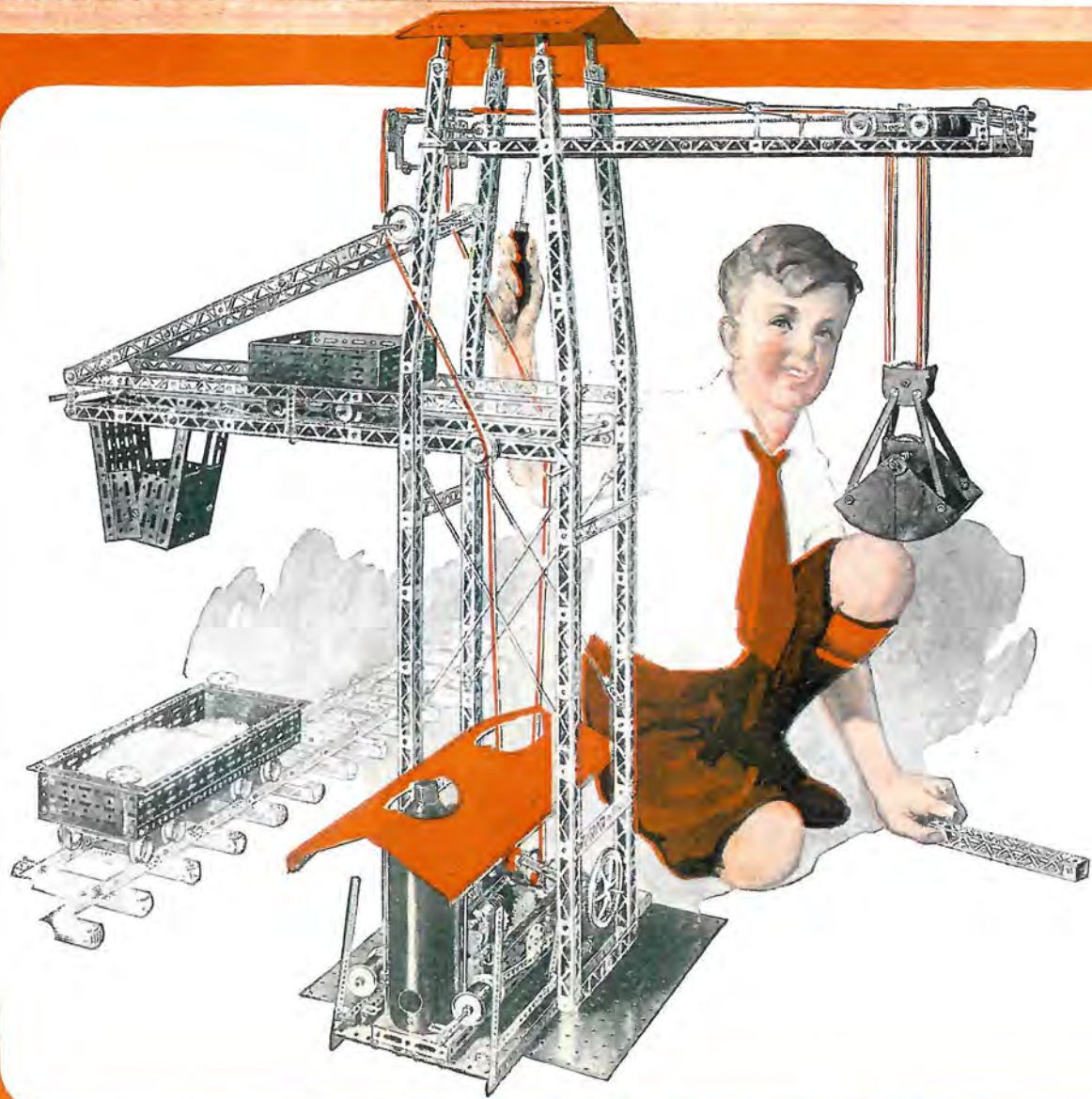

THE NEW **ERECTOR**

REG. U.S. PAT. OFF.

“The World’s Greatest Toy”

Always Improving - - Always Progressing
Bigger - - Better - - More Popular.

1926 New Features

1. 20 New Special Parts.
2. New Erector Motor and its Ten Big Features.
3. 200-page DeLuxe Manual.
4. 50 New Models.
5. New Motorized Parts in 1926 Erector
6. \$200,000.00 National Advertising Campaign
7. 25,000,000 Families will be reached.

Motorized New Erector Models

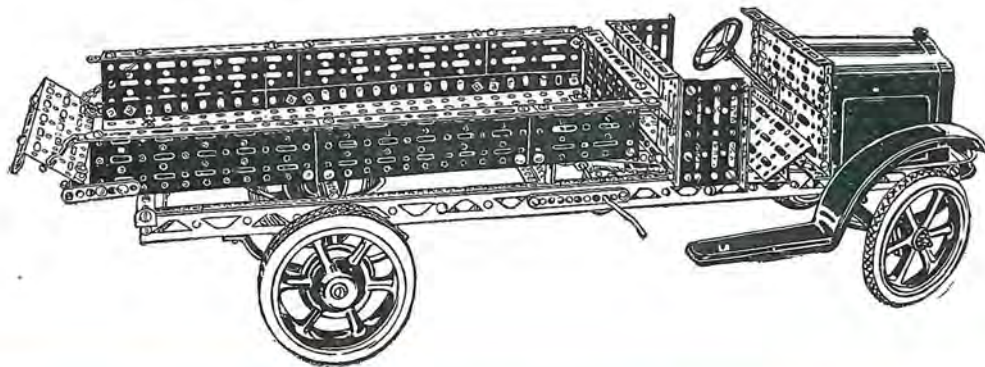
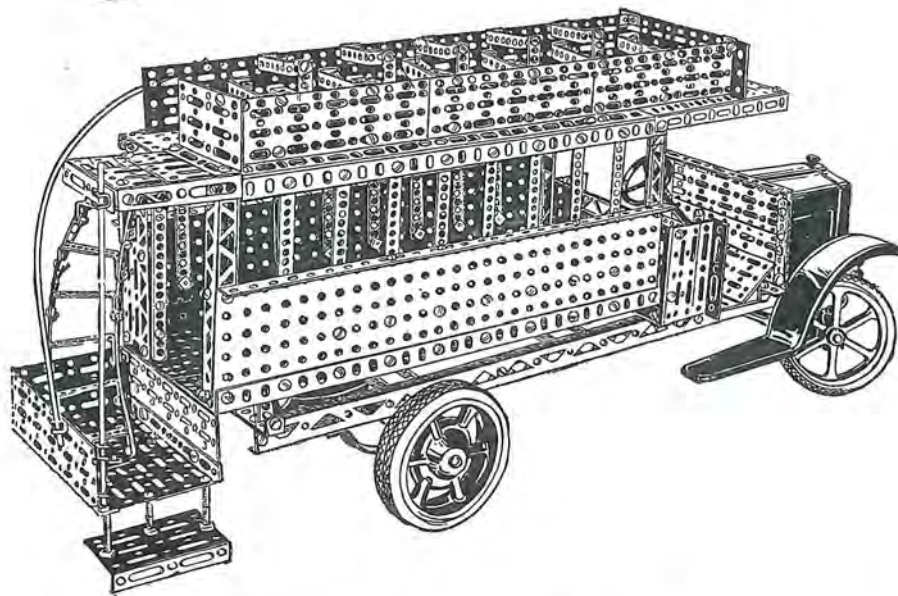
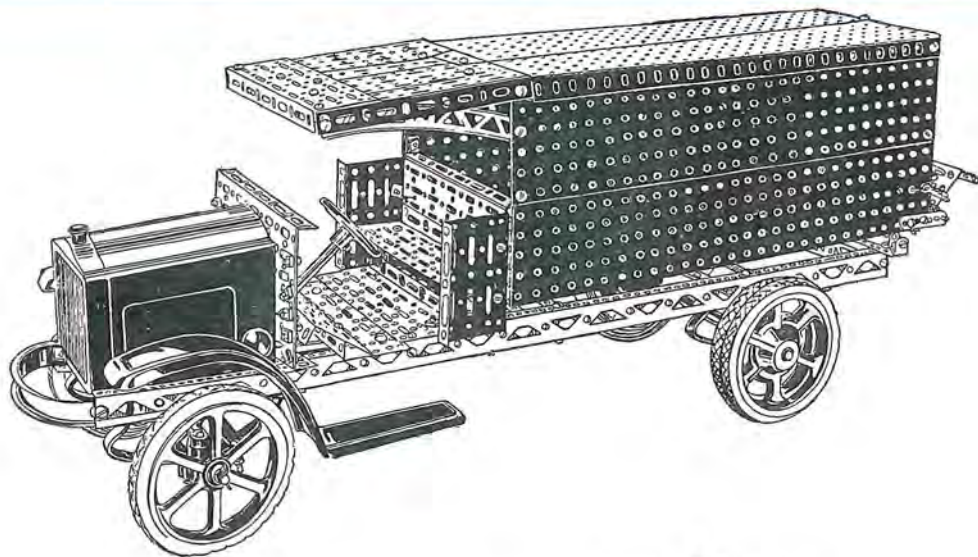

The Two Feature Erector Sets



Super No. 7 — Retails \$10.00

The Set that Made the Most Gain in Sales

Contains 473 parts. Builds 533 models. Has powerful electric motor. Stained and varnished wooden box with brass side grips and suitcase catches. Size $21\frac{1}{2} \times 8\frac{1}{2} \times 3\frac{1}{4}$ in. Individual wgt. 13 lbs., 3 ozs. Packed 6 to a carton. Weight per carton 85 lbs.

Famous No. 4 — Retails \$5.00

500 Models for \$5.00

Contains 235 parts (44 different parts). Builds 500 models. First set to contain a powerful electric motor. Size $18\frac{1}{4} \times 10\frac{1}{8} \times 2\frac{1}{2}$ in. Individual weight $4\frac{1}{2}$ lbs. Packed 6 to a carton. Weight per carton 33 pounds.



Exceptional Models Built From New Erector

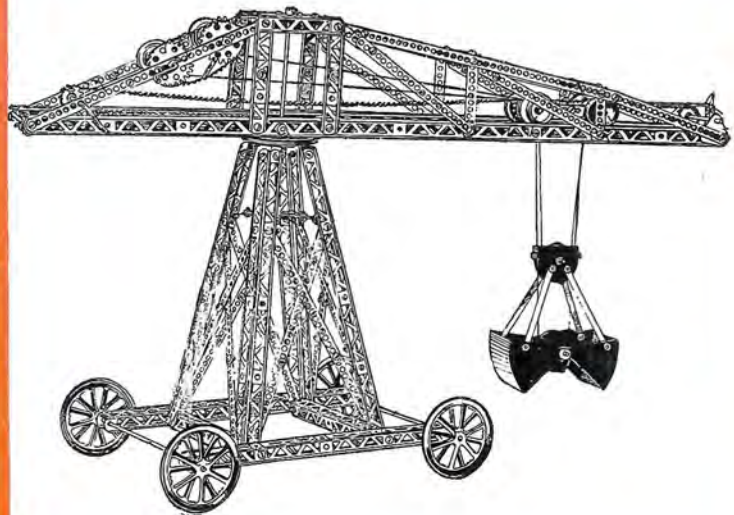
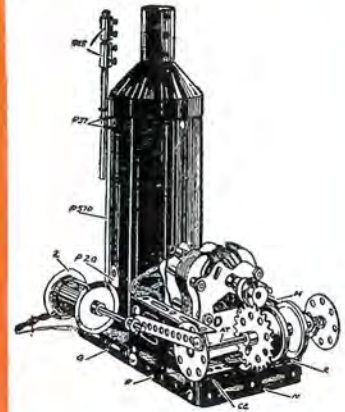
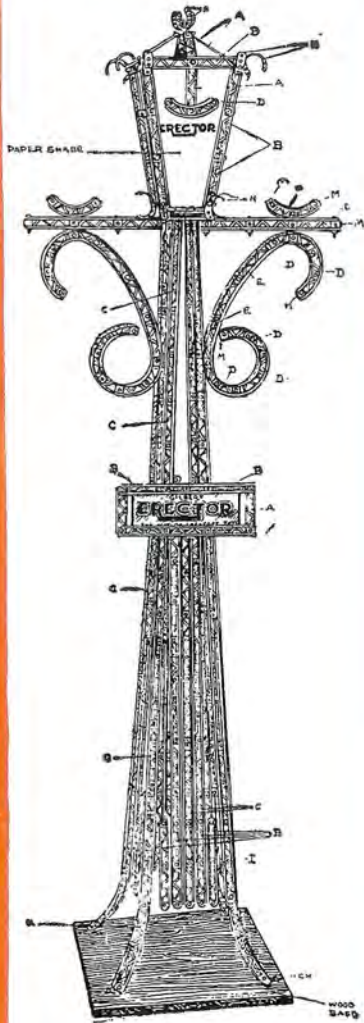
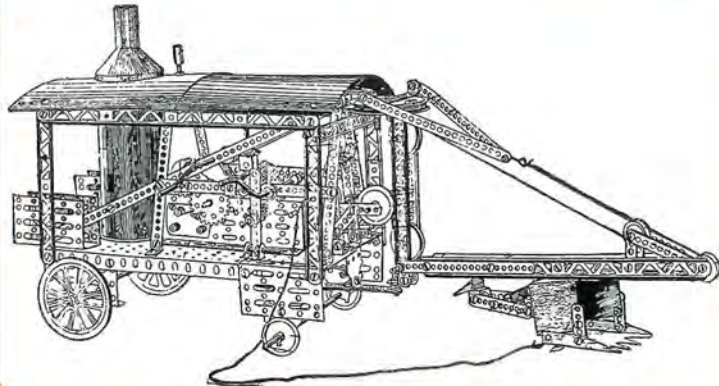

The New Erector Motor And Its Ten Big Features

P58 — Retails \$1.25

Strongest Battery Motor Of Its Size.

Operates on 6 to 12 volts by using Transformer or dry cells.



Especially useful in operating Erector and other mechanical toy models. Can be used with Reverse Base or Control Switch. Size 3 x 2 3/4 x 2 1/2 in. Individual weight 12 oz. Packed 12 to carton, Carton weight 11 lbs.

P54 — Retails \$2.00

Two terminal motor mounted on base, with reverse switch for operating backwards or forwards.



Size 4 1/4 x 4 1/4 x 4 1/4 in. Individual wgt. 1 lb. Packed 6 to carton. Carton wgt. 8 lbs.

P56G — Retails \$5.00

Powerful Universal Motor, 110 Volts

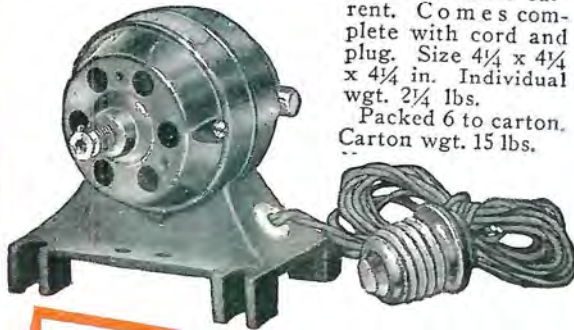

Operates on A. C. or D. C. house current. Comes complete with cord and plug. Size 4 1/4 x 4 1/4 x 4 1/4 in. Individual wgt. 2 1/4 lbs. Packed 6 to carton. Carton wgt. 15 lbs.

P60C Transformer — Retails \$3.50

Saves use of batteries by

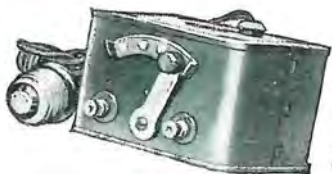

attaching to electric light socket. Operates on 110 volts, 60 cycles, A. C. only. Wattage 60. Primary taps 5 1/2, 10 1/2, 16 volts. Size 4 1/4 x 4 1/4 x 4 1/4 in. Individual wgt. 2 lbs. 8 oz. Packed 6 to carton. Carton wgt. 16 lbs.

1—The most powerful toy motor for its size in the world.

2—Accepted as the standard battery motor during the war by the Bureau of Standards. (Included in all sets from the Famous No. 4 up.)

3—Can be taken apart for experimental purposes.

4—Adaptable for use with R & CE Gear Box Side Plates, for various gear combinations.

5—Armature shaft same size as all shafting and axles.

6—Any gear or pinion can be directly attached to armature shaft.

7—Double drive shaft—pulleys and gears can be attached to both sides of motor.

8—Reverse can be attached to the motor.

9—Twelve steel laminated plates in both magnet and armature, which means power and efficiency.

10—Each purchaser is entitled to special leaflet, "25 Experiments with your Motor."



NEW GILBERT TOOL CHEST LINE

BIGGEST VALUES — BEST MADE — MOST TOOLS

FEATURING: 1. All regular numbers in varnished boxes with grips. 2. All saws set. 3. All real tools.

No. 701 Tool Chest — \$1.00
 Stained cabinet. Contains 10 tools. Size 10 3/4 x 8 1/2 x 1 1/4 in. Individual wgt. 2 1/4 lbs. Packed 12 to carton. Carton wgt. 30 lbs.

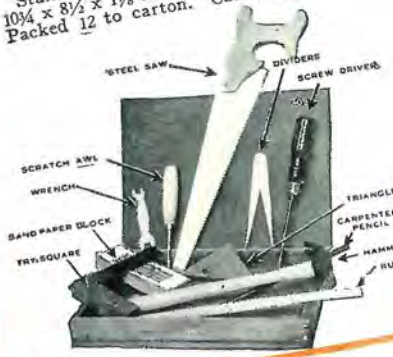

No. 702 Tool Chest — \$2.50
 Practical carpentry outfit of 13 tools, packed in stained hardwood cabinet. Size 17 x 7 1/8 x 3 1/4 in. Individual wgt. 4 lbs. 12 oz. Packed 9 to carton. Wgt. per carton 48 lbs.

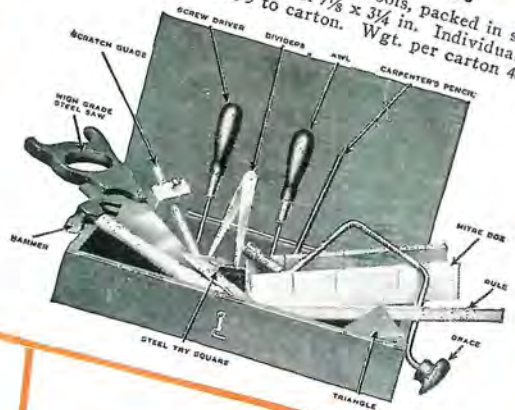

No. 707 Tool Chest — \$3.75
 Contains 16 tools in beautiful hardwood cabinet, stained and varnished. Brass side hand grips. Suitcase catches. Size 21 1/2 x 8 1/2 x 3 1/4 in. Packed 6 to carton. Individual wgt. 6 lbs. Wgt. per carton 42 lbs.

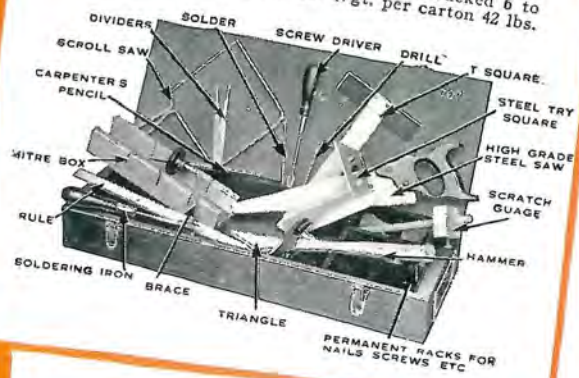

No. 765 Tool Chest — \$5.50
 Contains 22 tools in stained hardwood cabinet with hinges. Size 22 1/2 x 8 1/2 x 4 1/8 in. Individual wgt. 11 lbs. Packed 4 to carton. Carton wgt. 50 lbs.

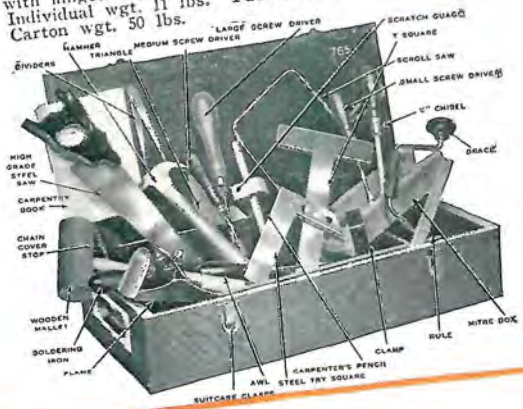

No. 770 Tool Chest — \$10.00

Complete carpenter's outfit of 30 tools. Comes in stained hardwood cabinet. Cabinet reinforced. Size 22 1/2 x 11 x 5 in. Packed singly. Individual wgt. 16 lbs.

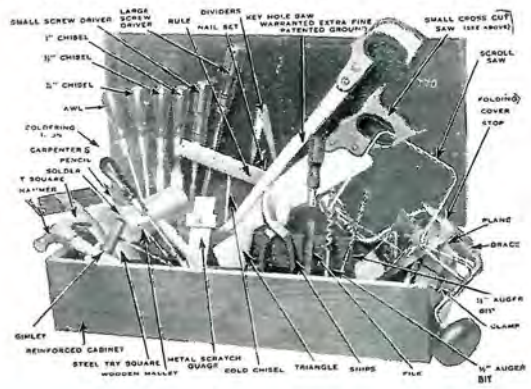

No. 775 DeLux Cabinet — \$18.50

Contains 33 better grade tools in expensive high grade finish cabinet. Size 22 1/4 x 12 1/2 x 7 in. Packed singly. Weight each 21 1/2 lbs.

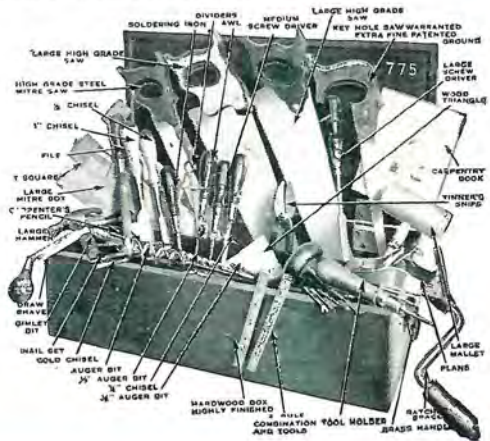

Wonderful Models Built With The New Erector

