



**GILBERT  
TOYS**

*The* **A.C. Gilbert**

NEW HAVEN, CONN., U.S.A.

**GENERAL SALES OFFICES**

221 Fourth Avenue  
NEW YORK CITY

# Gilbert Toys

Copyrighted 1918  
The A. C. Gilbert Company

*The prices and contents of sets shown in this  
catalog are subject to change without notice.*

*Prices quoted are retail. Write for discounts.*

TOYS THAT ARE GENUINE

## FOREWORD

Toys are Ideas—plus materials. Without the Idea behind it, no toy meets with success. Gilbert Toys are built on an Idea—The Idea of the Constructive Element in children's play. Gilbert Erector, Magic, Electrical, Chemistry and other Toys are made on this principle.

And the Idea is carried out as well as the best raw materials and skilled workmanship can do it. The result is "Toys that are Genuine."

This year Gilbert Toys will represent the greatest values we have ever given not only in quality and quantity of contents but also in the development of the original Idea which started them. For instance, the Gilbert Machine Gun of 1917 made a hit from the start, not only in the realism of its appearance and operation, but because of the Drill Manual Idea which accompanied it and made it possible for six boys to enjoy it in place of one. The new model is much finer in every way—in mount, barrel, feed, mechanism and finish. It's bound to be a big favorite all through the year.

Again, there are the Gilbert Chemistry Sets. Last season they sold faster than we could supply the demand. This year the new sets contain more material and apparatus and are packed in a much more appealing way.

What we have said of Machine Guns and Chemistry Sets is true of Wireless Telegraph, Magic and all the other Gilbert Toys. They are better than ever.

We illustrate and describe many of them in the following pages.

We ask you to study the descriptions. You will note the new items: Gilbert Tele-Set, Gilbert Phono-Set, Gilbert Tumbling Clowns, and the additions we have made to the already well-known Gilbert Toys.

Upon request we will gladly have our salesman call or send you samples.

*A.C. Gilbert* President,

## THE A. C. GILBERT COMPANY,

NEW HAVEN, CONNECTICUT, U. S. A.

In Canada

The A. C. Gilbert-Menzies Co., Limited, Toronto, Ont.

## Our Rapid Growth.

Since 1909 the "Gilbert Toy" business has grown from zero to over a million dollar business. It has grown on the real merit of the products, assisted by the whole-souled co-operation between jobbers, dealers, consumers and the factory.

We started with a vision of a broader toy business of toys which would appeal to the boys' imagination as well as giving them a lot of fun.

Beginning with the making of Tricks and Magic with a working force of less than half a dozen, the business shot forward at a fast pace, making in 1912 the Foote Street Plant necessary.

Then with the rapid sales of ERECTOR beginning in the fall of 1913, we found that by 1915 we needed a big modern plant which we built on Fox Street.

The big idea developed in the 1916 campaign called "Gilbert Toy Engineering" which connected with ERECTOR, BRIKTOR and the ELECTRICAL SETS, forced us to again obtain more room so that in January, 1917, we moved into our present big plant.

Such, briefly, is the story of the great success of "Gilbert Toys"—the success which we want every dealer and boy and girl in the whole world to share with us.

TOYS THAT ARE GENUINE



Original Plant, Westville  
1909-1912

Foote Street Plant  
1912-1915

Fox Street Plant  
1915-1917

Present Plant

## The Gilbert Engineering Institute for Boys.

This plan evolved as a result of the immense interest boys had shown for miniature engineering through thousands of unsolicited letters written personally to Mr. Gilbert. This scheme was, therefore, developed to sustain and increase this interest by putting engineering on a miniature basis, enabling boys to have an engineering world of their own, making them proud to talk about it among their playmates as well as creating an appeal to the boys' parents, because it makes the boy think along constructive lines.

The Gilbert Engineering Institute awards gold watches, gold pins, recommendation for a position also diplomas suitable for framing for three degrees, viz., First Degree: Gilbert Engineer; Second Degree: Gilbert Expert Engineer; Third Degree: Gilbert Master Engineer. To win the various degrees it is necessary for the boys to build with and answer questions covering Erector, Brik-tor, Electrical Sets, and Wireless Telegraph Outfits.

There is a great parent appeal back of this unusual scheme as they realize that an investment in these toys is the best investment they could ever make for the future of their boy. The boy is taught while at play the elementary principles of Mechanical, Electrical, Architectural Engineering and also Wireless operating.

This remarkable merchandising plan makes each "Engineering Toy" a real salesman for each of the other toys, thus resulting in a special line of excellent sellers.



Gilbert Toys

GILBERT  
**ERECTOR**  
REG. U.S. PAT. OFF.

“The Toy Like Structural Steel”.

Only a few years ago Mr. Gilbert first worked out the fundamental principle of Erector construction, viz., the square steel girder with interlocking edges. It seems a far cry back to those days of the first models made with cardboard and tin to the finished Erector of today—the best known toy in the world.

Why Erector has gained success so quickly is answered by the fact that it is actually “like structural steel.” It is a real steel building material although in miniature, and boys appreciate the *real thing*.

Every Erector part is mechanically correct; the girders are exactly like the big steel girders used in big buildings and sky-scrapers. The lapped interlocking edges of these girders enable the boy to build four-sided or square columns. Every essential engineering part is included in Erector Sets, enabling boys to build the most realistic, strongest, largest and more models than with any other steel building toy.

Then there is the sturdy electric motor which comes with most sets and which, when properly geared, enables boys to operate machinery models built with Erector.

Every year improvements have been made, making the sets more attractive, improving various parts and adding to the engineering features by introducing entirely new and original devices. This year the big three-section gear wheel, mitre gears, twelve-tooth gear wheel, combination crown pulleys, etc., will still further popularize and increase the sale of Erector.

All of the smaller sets are packed in the individual Gilbert Toy sealed cartons, with four color varnished label. Larger sets come in stained hardwood cabinets.

The Gilbert Engineering Institute For Boys is built around Erector, which holds the most important place; and the highest degree can only be obtained when the boy has built an original model with Erector.

TOYS THAT ARE GENUINE

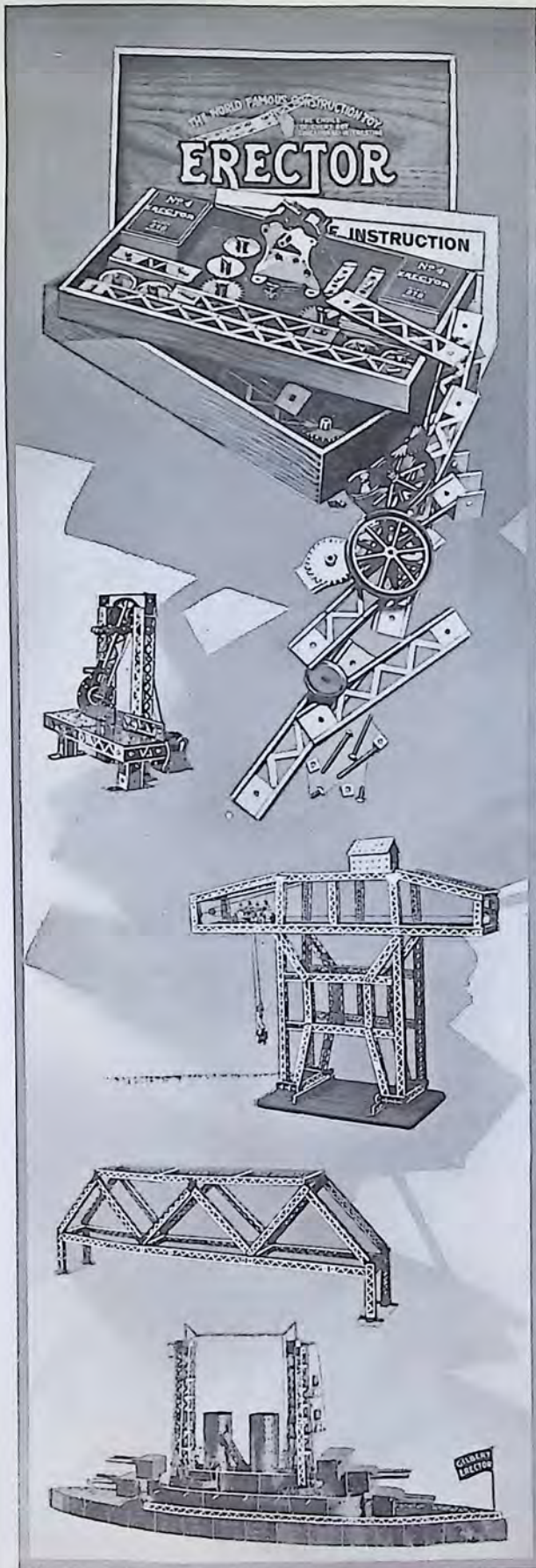

## ERECTOR Sets.

### ERECTOR Set No. 1.

Retail Price, \$1.00. (Canada \$1.50.)

Box:—New Sealed Carton, 12¼ x 8¾ x 1¼".  
Models:—Makes 111 models. Weight:—1 lb. 10 oz.

### ERECTOR Set No. 2.

Retail Price, \$2.00. (Canada \$3.00)

Box:—New Sealed Carton, 12¼ x 8¾ x 1¼".  
Models:—Makes 152 models. Weight:—2 lb. 8 oz.

### ERECTOR Set No. 3.

Retail Price, \$3.00. (Canada \$4.50)

Box:—New Sealed Carton, 12¼ x 8¾ x 2½".  
Models:—Makes 197 models. Weight:—3 lb. 9 oz.

### ERECTOR Set No. 4.

Retail Price, \$5.00. (Canada \$7.50)

Box:—Hard-wood cabinet, 13 x 9 x 3". Weight:—7 lb.  
Motor:—Contains electric motor.  
Models:—Makes 278 models.

### ERECTOR Set No. 5.

Retail Price, \$7.50. (Canada \$11.25)

Box:—Hard-wood cabinet, 15 x 9 x 3". Weight:—8 lb. 13 oz.  
Motor:—Contains electric motor.  
Models:—Makes 317 models.

### ERECTOR Set No. 6.

Retail Price, \$10.00. (Canada \$15.00)

Box:—Hard-wood cabinet, 15 x 10 x 4". Weight:—12 lb. 14 oz.  
Motor:—Contains electric motor.  
Models:—Makes 382 models.

### ERECTOR Set No. 7.

Retail Price, \$15.00. (Canada \$22.50)

Box:—Hard-wood cabinet, 12¼ x 20¼ x 3½".  
Weight:—18 lb. 5 oz.  
Motor:—Contains reversing electric motor.  
Models:—Makes 410 models.

### ERECTOR Set No. 8.

Retail Price, \$25.00. (Canada \$37.50)

Box:—Hard-wood cabinet, 12¼ x 20¼ x 4¾".  
Weight:—32 lb. 8 oz.  
Motor:—Contains reversing electric motor.  
Models:—Makes 454 models.

### ERECTOR Accessory Sets

Sets from No. 1 to No. 7 may be made equal to the next larger set with these "A" Outfits, which do not duplicate the parts already contained in the regular sets. Viz., No. 1-A Set makes No. 1 equal to the No. 2 Outfit, etc.

Sets Nos. 1A, 2A and 3A packed in New Sealed Cartons. All others in Stained Hard-wood Cabinets.

No.	No.	No.	Price.
1-A makes	1	equal to 2	Set. \$ 1.00 (Canada \$1.50)
2-A makes	2	equal to 3	Set. 1.00 (Canada 1.50)
3-A makes	3	equal to 4	Set. 2.00 (Canada 3.00)
4-A makes	4	equal to 5	Set. 2.50 (Canada 3.75)
5-A makes	5	equal to 6	Set. 2.50 (Canada 3.75)
6-A makes	6	equal to 7	Set. 5.00 (Canada 7.50)
7-A makes	7	equal to 8	Set. 10.00 (Canada 15.00)

**ERECTOR**  
REG. U.S. PAT. OFF.

**Master Engineer Set.**

This is a specially designed Erector Outfit for the advanced Erector Boy Engineer. The boy can do even more with it than with the standard Erector Sets, as the special twelve-inch girders two inches wide enables him to duplicate the real "I" and "T" beams. The new type of gears such as the twelve-tooth, the big three-section gears, mitre gears, combination crown pulleys, together with chains and belting for transmissions are also specially designed features.

This is a new idea in steel construction toys and is rapidly becoming one of the most popular and best selling Erector Outfits. Every Erector assortment should include several of these sets.

**Master Engineer Set No. 44.**

Retail Price, \$5.00. (Canada \$7.50)

Box:—Hard-wood Cabinet.

Size:—13 x 9 x 3". Weight:—7½ lb.

**ERECTOR**  
REG. U.S. PAT. OFF.

**Parts Cabinet.**

Erector separate parts business creates and sustains the all-year sales of Erector.

The illustration pictures the cabinet which is sent free with every \$45.00 (\$67.50 Canada) worth of separate parts at retail.

Cabinet is made of hard-wood, stained and well finished with glass top which makes it easy for the customer to point out exactly what is wanted and enables the dealer to easily handle these profitable sales.

**ERECTOR Parts Cabinet No. 2.**

Retail Price, \$45.00. (Canada \$67.50)

Size:—17¼ x 25½ x 10½". Weight:—50 lb.

**ERECTOR Parts Cabinet No. 3.**

Retail Price, \$22.50. (Canada \$33.75)

Size:—12¼ x 20¼ x 3¼". Weight:—20 lb.

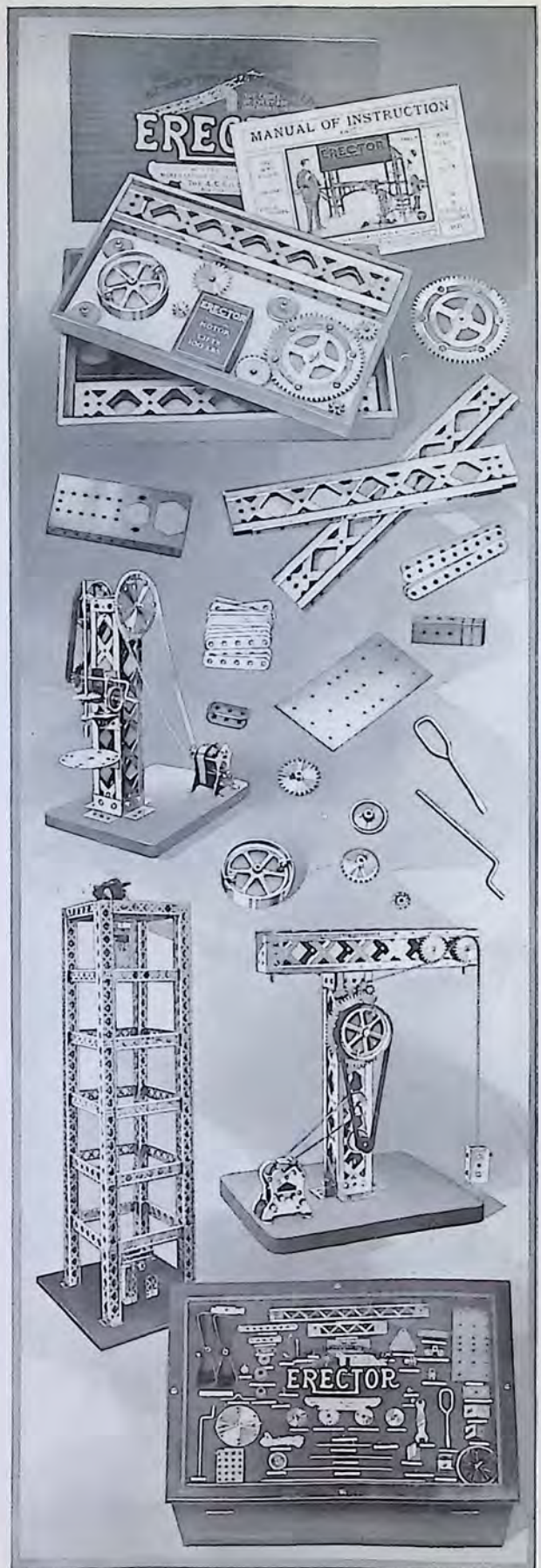

**GILBERT**

**Chemistry Outfit for Boys.**

A new idea! The most fascinating and interesting chemicals which are safe and fool-proof, enabling a child to perform the most interesting experiments. Thoroughly illustrated Manual gives complete instructions and explains in very simple boy language the "how" and "why" of every stunt, thus giving him a good foundation of chemical knowledge while at play.

Following are a few of the many features:

Wet cell equipment together with necessary apparatus and chemicals for electroplating, nickel-plating; test for metals; how to make soap; how to make ammonia; how to make ink; how to perform chemical magic tricks.

Sets Nos. 5001 and 5003 packed in the new sealed carton with four color, varnished label.

No. 5004 comes in wooden cabinet, a complete laboratory in itself.

**No. 5001.**

**Retail Price \$1.50. (Canada, \$2.25)**

Box:—New Sealed Carton,  $12\frac{1}{4} \times 8\frac{3}{4} \times 1\frac{1}{4}$ "  
Weight:—1 lb. 2 oz.

**No. 5003.**

**Retail Price \$3.00. (Canada, \$4.50)**

Box:—New Sealed Carton,  $18 \times 10 \times 1\frac{1}{4}$ "  
Weight 1 lb. 15 oz.

**No. 5004.**

**Retail Price, \$5.00. (Canada, \$7.50)**

Box:—Wooden Cabinet.  $13 \times 8\frac{1}{4} \times 3\frac{1}{4}$ "  
Weight:—3 lbs. 6 oz.



Gilbert Toys

## **GILBERT** **Electrical Toys.**

The very Toys to Electrify your Sales.

Where is the toy dealer who cannot count among his customers a large percentage of boys who hope to become Electrical Engineers some day?

Gilbert Electrical Toys teach the boy while at play the fundamentals of electrical science. The line comprises four Electrical Sets which cover static electricity, constructing electric Magnets, wiring door bells, electric lights and many other interesting experiments. The Gilbert Tele-Set is a practical telegraph outfit which will operate from room to room, or house to house. The Gilbert Phono-Set, a real working telephone toy is an entirely new toy for which there has been a great call. The Gilbert Wireless Telegraph Outfit teaches the boy the theory of wireless operating. It operates with buzzer instead of ticker.

A complete Manual of Instruction is included with every set; written in boy language, entirely getting away from the ordinary text book style so that the boy is kept interested and keenly anxious performing the many experiments.

All of the smaller sets are packed in the individual Gilbert Toy Sealed package with four color, varnished label. Large electrical sets come in stained hardwood cabinets, complete electrical laboratories in themselves.

TOYS THAT ARE GENUINE



3502

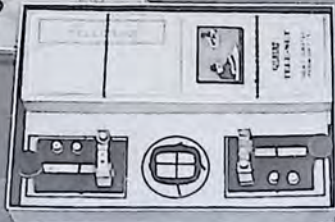

## GILBERT

### Tele-Set.

Retail Price, \$1.75. (Canada, \$2.70)

Box:—New Sealed Carton,  $12\frac{1}{8} \times 8\frac{3}{8} \times 2$ "  
Weight:—1 lb. 2 oz.

Description:—Complete telegraph outfit, including two keys, wire, telegraph blanks, manual of instructions, etc. Manual is clearly illustrated and describes telegraphy and its uses in a very interesting way.

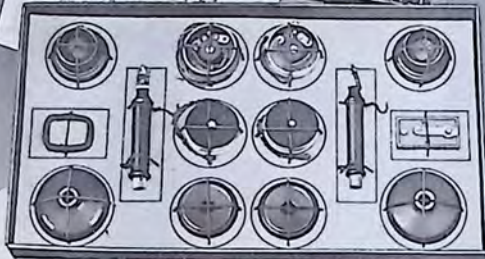

3503

## GILBERT

### Phono-Set.

Retail Price, \$3.95. (Canada, \$5.95)

Box:—New Sealed Carton,  $18 \times 10 \times 1\frac{1}{4}$ "  
Weight:—2 lb. 1 oz.

Description:—A real working miniature telephone outfit. It will operate from garret to cellar or room to room. Contains two complete stations which are to be assembled; as well as wire for connections and detailed manual of instructions.



4004-T

## GILBERT

### Wireless Telegraph Outfit

Retail Price, \$5.00. (Canada, \$7.50)

Box:—New Sealed Carton,  $18 \times 10 \times 1\frac{1}{4}$ "  
Weight:—3 lb. 2 oz.

Description:—Contains complete apparatus together with illustrated manual of instructions teaching the boy the fundamentals of Wireless. It will be converted into a real wireless outfit as soon as government restrictions are removed at no expense to the boy purchaser. In the meantime it is to be used as wireless telegraph set, operating with buzzer instead of ticker.

## GILBERT Electrical Sets.

### Electrical Set No. 3001.

Retail Price, \$1.00. (Canada, \$1.50)

Box:—New Sealed Carton,  $12\frac{1}{4} \times 8\frac{3}{4} \times 1\frac{1}{4}$ "  
Weight:—1 lb. 4 oz.

Description:—Complete outfit for teaching the fundamentals of static electricity and magnetism, giving the theory and practical principles of this science. Manual included with the Set illustrates and describes thoroughly each of the experiments in detail.

### Electrical Set No. 3002.

Retail Price, \$1.95 (Canada, \$2.95)

Box:—New Sealed Carton,  $12\frac{1}{4} \times 8\frac{3}{4} \times 1\frac{1}{4}$ "  
Weight:—1 lb. 8 oz.

Description:—This Outfit contains all parts for building a complete electric motor. Also apparatus and Manual enabling one to gain a knowledge of current electricity, electrotyping, electroplating, how to connect electrical magnetic current, wire electric lights, door bells and other practical every-day uses of electricity.

### Electrical Set No. 3003.

Retail Price \$3.75. (Canada, \$5.65)

Box:—New Sealed Carton,  $18 \times 10 \times 1\frac{1}{4}$ "  
Weight:—3 lb. 2 oz.

Descriptions:—The same experiments can be performed with this outfit as with the set No. 3002 and in addition is included illustrated manual and apparatus teaching the essentials, laws of electrical machinery, how to control and reverse current, connect motor multi-gearred box, a combination which develops a surprisingly powerful unit for driving models, lifting weights, etc.



## GILBERT Electrical Sets.

### Electrical Set No. 3004.

Retail Price, \$5.00. (Canada, \$7.50)

Box:—Hard-wood Cabinet, 13 x 9 x 3".  
Weight:—3 lb. 14 oz.

Description:—This little electrical laboratory is a complete outfit to teach the boy the fundamental laws of electricity including magnetism, static electricity, current electricity and the laws of gears and electric machinery. It also contains a working model of an electric sounder, enabling the boy to study and exercise practical telegraphy.

### Electrical Set No. 3006.

Retail Price, \$10.00. (Canada \$15.00)

Box:—Hard-wood Cabinet, 20¼ x 12¼ x 3½".  
Weight:—15 lb.

Description:—This is the most complete Electrical Outfit made for boys. It contains complete apparatus and Manual of Instructions covering static electricity, magnetism, current electricity, dynamic electricity, and also includes parts for constructing the powerful Erector Motor and Erector Generator which a boy puts together himself, thereby teaching him the fundamental principles of how electricity is produced.



Gilbert Toys

**GILBERT**

## Miniature Machinery.

This is the latest addition to the Gilbert Line. It comprises a very extensive line of Toy Machines which will actually operate exactly like the real machines of which they are miniature models. With them a boy can cut scroll saw designs, stamp out thin sheet metal, do wood turning, and many other things. They are very strongly made of cast-iron and cold rolled steel. Cast iron parts are finished in black japan, steel parts, beautifully nickel-plated.

This line has a great deal of merit and should prove to be a very ready seller. It will be advertised with all the other Gilbert Toys in the leading boys' papers and biggest national weeklies.

There is a wide range of articles from a simple machine which sells for one dollar (\$1.00) to a complete machine shop at twenty-five dollars (\$25.00). Your boy customers can find some machine in the line for just the price they want to pay.

TOYS THAT ARE GENUINE

## Miniature Machinery.

### Circular Saw, No. 201.

Retail Price, \$1.00 (Canada, \$1.50)

A true model of the buzz saw used in log mills. It is built foolproof with a safety guard and all danger is eliminated.

It will actually cut wood up to  $\frac{1}{16}$ " thick.

The base is cast iron finished in black japan; the table nickel plated.

Dimension—4 x  $3\frac{3}{4}$  x  $3\frac{1}{4}$ ". Weight—1 lb.

Packed one in a carton.

### Scroll or Jig Saw, No. 202.

Retail Price, \$2.50 (Canada, \$3.75)

This is one of our best sellers and will afford more pleasure than most any toy. Many attractive designs can be cut with it. Will use wood up to 9" long; large enough for most any scroll or fret-work design.

The base and standards are of cast iron, black japanned; other parts are made of cold rolled steel, nickel plated.

Dimension— $7\frac{1}{4}$  x  $2\frac{1}{2}$  x 5". Weight— $2\frac{1}{4}$  lbs.

Packed one in a carton.

### Surface Grinder or Sander, No. 203.

Retail Price, \$1.00 (Canada, \$1.50)

A practical toy for sanding the surface or edges of wood. Very neat design, made of cast iron, finished in black japan.

Dimension— $3\frac{1}{2}$  x  $3\frac{1}{2}$  x  $4\frac{3}{4}$ ". Weight— $1\frac{1}{2}$  lbs.

Packed one in a carton.

### Emery and Buffing Wheel, No. 204.

Retail Price, \$2.00 (Canada, \$3.00)

This is really not a toy but a practical household utility item.

It is a real Emery Wheel on which one may sharpen knives and tools and a felt Buffing Wheel on which to polish silverware.

It is made of cast iron and has black japan finish.

Dimension— $4\frac{1}{4}$  x  $2\frac{1}{2}$  x  $4\frac{1}{4}$ ". Weight—1 lb.

Packed one in a carton.

### Drill Press, No. 205.

Retail Price, \$2.00 (Canada, \$3.00)

This drill press will drill through thin sheet metal wood or cardboard. No toys were ever produced so practical. Finished in black enamel, with nickel plated parts. Made of cast iron.

Dimension— $4\frac{1}{2}$  x  $2\frac{3}{4}$  x  $6\frac{3}{4}$ ". Weight—1 lb.

Packed one in a carton.

### Wood Turning Lathe, No. 207.

Retail Price, \$3.00 (Canada, \$4.50)

This lathe is a wonderful item and must be seen in operation to be appreciated.

Takes wood 4" long x  $\frac{5}{8}$ " thick, and turns up any style spindles.

Many hours can be pleasantly spent turning out numerous designs, such as stool pins, ten pins, gavels, mallets, Indian clubs, pillars, men for all kinds of games, etc.

Made of Cast iron, black japanned with nickel plated parts.

Dimension— $9\frac{1}{2}$  x  $3\frac{1}{2}$  x  $4\frac{1}{2}$ ". Weight— $2\frac{3}{4}$  lbs.

Packed one in a carton.

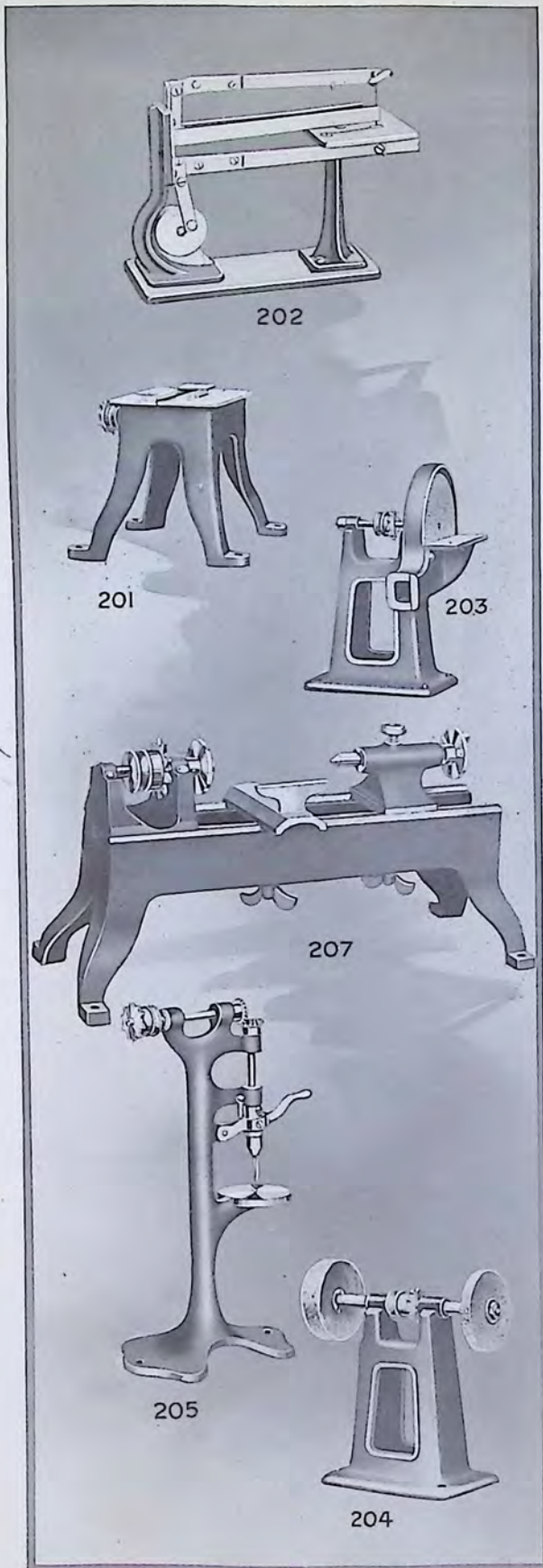

**GILBERT**  
**Miniature Machinery**  
**with motors.**

**Scroll or Jig Saw with Motor, No. 209.**

Retail Price, \$4.50 (Canada, \$6.75)

This scroll or jig saw is same as No. 202 with driving motor attached. Large enough to use wood up to 9" long. Very strongly built and a practical item. Will furnish a great deal of amusement.

Made of cast iron, Black japan finished.

Dimensions—10 x 4 x 5".

Weight—4½ lbs.

Packed one in a carton.

**Emery and Buffing Wheel with Motor, No. 210.**

Retail Price, \$4.00 (Canada, \$6.00)

A practical working toy which will sharpen knives, tools, polish silver, etc. Motor which is attached drives machine at a steady rate.

Made of cast iron. Finished in black japan.

Dimensions—9 x 4 x 4½".

Weight—3 lbs.

Packed one in a carton.

**Drill Press with Motor, No. 211.**

Retail Price, \$4.00 (Canada, \$6.00)

This drill press will drill through sheet metal, wood or card board. Motor attached drives at a regular speed. Works exactly like real machines used in factories. Made of cast iron. Finished in black japan.

Dimension—6¼ x 2¾ x 7¼".

Weight—2½ lbs.

Packed one in a carton.

**Power Wood Turning Lathe.**  
**Motor attached, No. 213.**

Retail Price, \$5.00 (Canada, \$7.50)

Takes wood 4" long x 5/8" thick, and turns up any style spindles. As in all other direct connected miniature machinery the link belt or chain is used for the transmission of power, assuring a steady, even pull on the driving wheel.

Made of cast iron. Finished in Black japan with nickel plated trimmings, and comes complete with wood turning gauge.

Dimensions—9½ x 5½ x 4¾".

Weight—4 lbs.

Packed one in a carton.



211

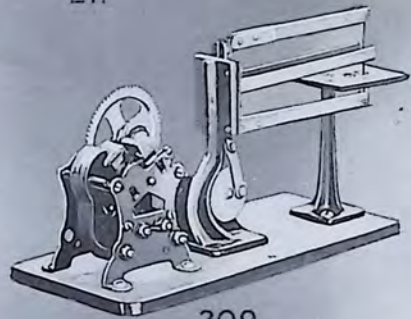

209

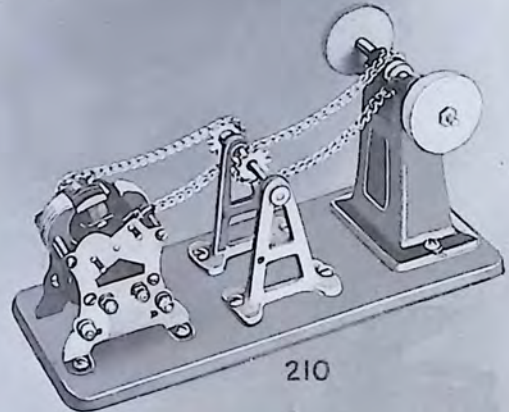

210

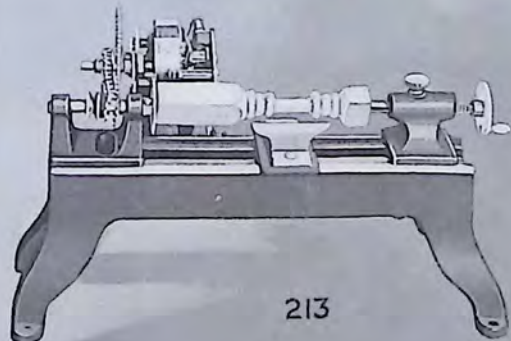

213

**GILBERT**

**Miniature Machine Shops.**

**Machine Shop, No. 214.**

Retail Price, \$6.50 (Canada, \$9.75)

This is a combination of the Scroll Saw No. 202, Drill Press No. 205 and P-58 Gilbert Motor; all mounted on a solid and very nicely finished baseboard.

Complete outfit will operate on either Batteries or transformer current. This combination is a very good seller.

Dimension—14 x 5 x 7 $\frac{3}{4}$ ".

Weight—6 lbs.

Packed one in a carton.

**Machine Shop, No. 215.**

Retail Price, \$8.00 (Canada, \$12.00)

Combination of Wood Turning Lathe No. 207, Surface Grinder or Sander No. 203 and P-58 Gilbert Motor.

The motor power is transmitted to the machines by means of a link belt or chain.

The whole outfit is mounted on a substantial, very attractively finished baseboard.

Dimension—12 x 12 x 6".

Weight—6 lbs.

Packed one in a carton.

**Machine Shop, No. 217.**

Retail Price, \$12.00 (Canada, \$16.00)

A very practical Wood Turning Outfit. This is a combination of our No. 207 Lathe with the B-685 110 Volt, Universal Gilbert Motor, 1130 H. P. This Motor will run on either Direct or Alternating current, 110 volts up to 60 cycles and comes complete with five ft. cord and attachment plug, ready to be connected to any lamp socket convenient.

The combination is mounted on a substantial, nicely finished base-board.

Dimension—12 x 12 x 6".

Weight—6 lbs.

Packed one in a carton.

**Machine Shop, No. 218.**

Retail Price, \$13.50 (Canada, \$20.25)

A complete wood working outfit including Drill Press No. 205, Jig or Scroll Saw No. 202, and B-685 Universal Motor which will operate on 110 volts, direct or alternating home current, up to 60 cycles.

Owing to the use of this powerful motor this Combination is not only a toy but a practical outfit for all kinds of experimental and stencil work.

The Combination is mounted on a substantial, nicely finished base-board.

Dimension—12 x 7 x 7 $\frac{3}{4}$ ".

Weight—8 lbs.

Packed one in a carton.

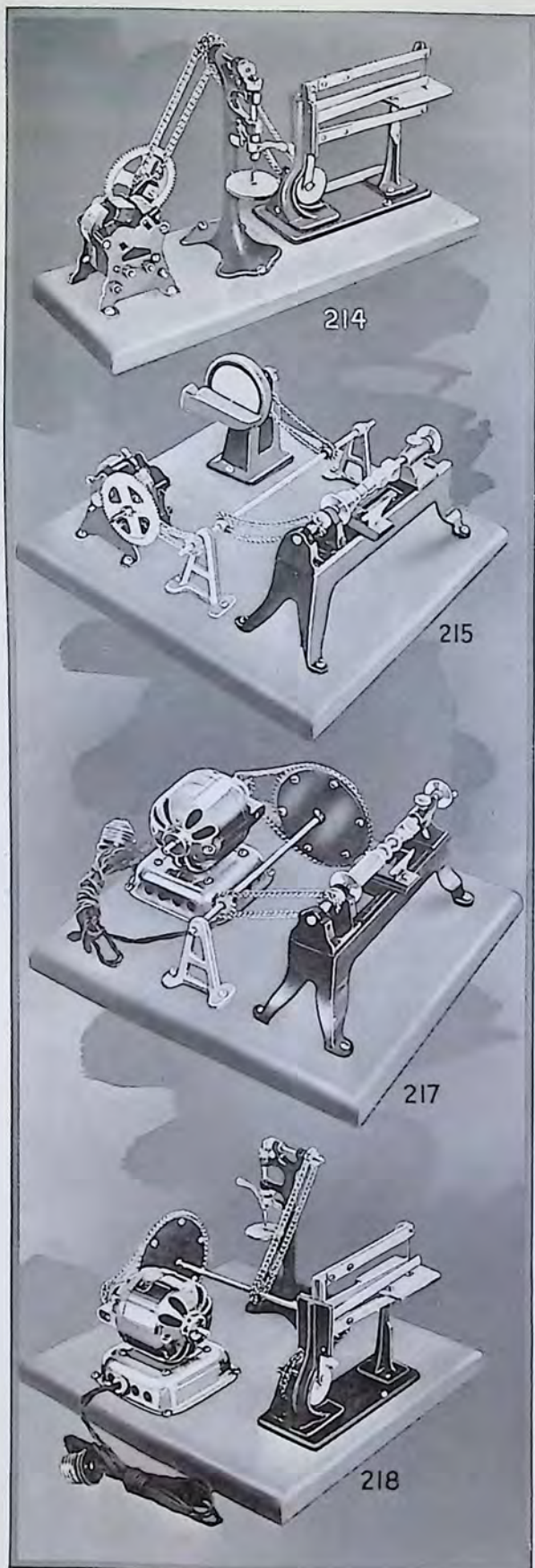

## Miniature Machine Shops.

### Machine Shop, No. 216.

Retail Price, \$10.00 (Canada, \$15.00)

A complete Wood Working Outfit consisting of the Drill Press No. 205, Jig or Scroll Saw No. 202 and B-686 Gilbert Electric Motor.

All mounted on a substantial, very neatly finished base-board.

A line shaft is provided to transmit the power from the motors to the machines.

This Outfit will operate on either dry batteries or transformer current.

Dimensions, 12 x 12 x 7 $\frac{3}{4}$ ".

Weight—7 lbs.

Packed one in a carton.

### Machine Shop, No. 219.

Retail Price, \$18.00 (Canada, \$27.00)

A complete Wood Turning Plant consisting of Wood Turning Lathe No. 207, Circular Saw No. 201, Scroll Saw No. 202, Surface Grinder No. 203, all driven by a powerful B-685 Gilbert 110 volt Universal Motor, which will run on either Direct or Alternating 110 volt Current up to 60 cycles.

The Outfit comes complete with cord and attachment plug ready to be connected to any conveniently located lamp socket.

This is a very desirable outfit and should find a ready sale.

Dimensions—8 x 12 x 6".

Weight—13 $\frac{1}{2}$  lbs.

Packed one in a carton.

### Complete Machine Shop, No. 220.

Retail Price, \$25.00 (Canada, \$37.50)

This is a combination of all the Miniature Machines illustrated in this catalog, with the addition of a Punch Press on which paper, thin card-board or fiber board may be punched. This operates by B-685 Gilbert 110 volt Universal Motor. The line shaft running clear across the board, furnishes the means of transmitting power to the individual machines. This will operate on either Direct or Alternating Home current up to 60 cycles and comes complete with cord and attachment plug to be connected to any lamp socket.

This is not only a wonderful seller but also an automatic salesman if used as display or demonstration board.

Dimension—30 x 12 x 8".

Weight—19 lbs.

Packed one in a corrugated carton.

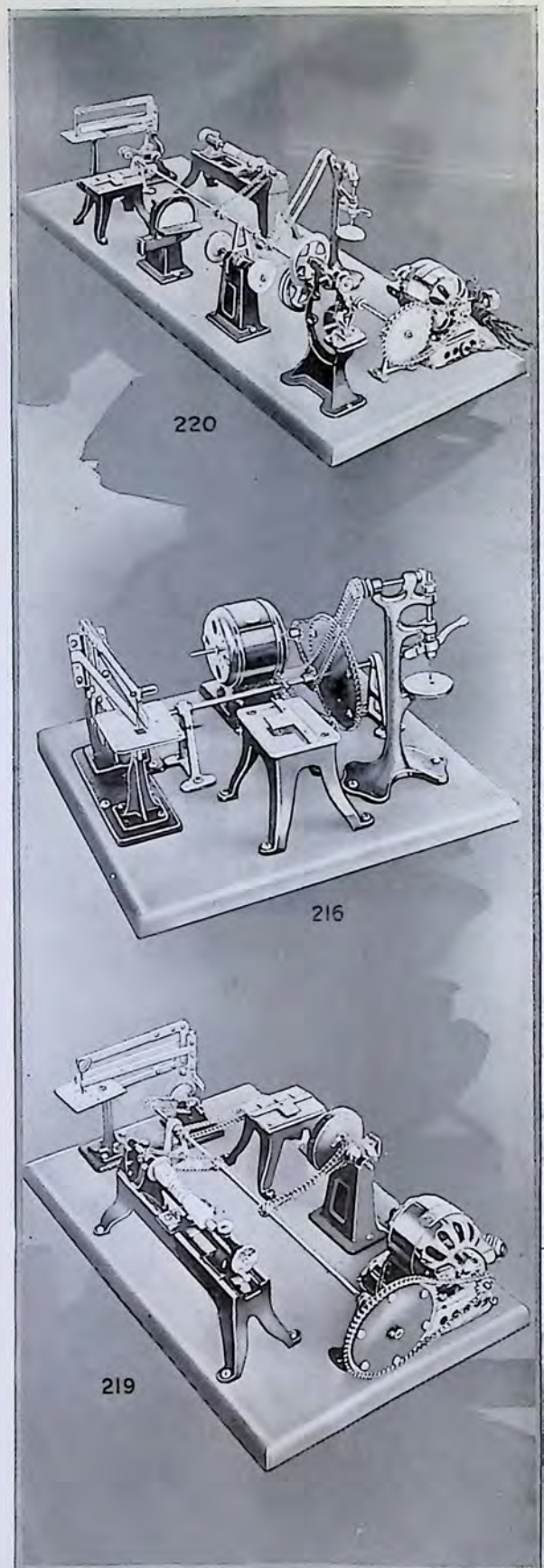

## Toy Motors.

### P-54 Motor.

Retail Price, \$2.00 (Canada, \$3.00)

Height:— $3\frac{3}{4}$ " Weight:—14 oz.

Description:—Mounted on Reverse Switch Base. Operates on either battery current or by attaching direct to transformer.

### P-53 Motor.

Retail Price, \$1.50 (Canada, \$2.25)

Height:— $3\frac{3}{4}$ " Weight:—14 oz.

Description:—Has two terminals, pressed steel base, latest type tabular holders with copper gauze brushes. Operates on either battery current or by attaching direct to transformer.

### P-52 Motor.

Retail Price, \$1.00 (Canada, \$1.50)

Height:— $3\frac{3}{4}$ " Weight:—8 oz.

Description:—Two-terminal motor for operating light running models. Operates on either battery current or attached to Transformer.

### P-58 Motor.

Retail Price, \$1.50 (Canada, \$2.25)

Height:— $2\frac{3}{4}$ " Weight:—12 oz.

Description:—Made specially for operating Erector and Mechanical Toy models. Can be made reversible by attaching to Reverse Base P-59 and the speed can be controlled by attaching to Control Switch P-61. Operates on battery or transformer current.

### B-685 Universal Motor.

Retail Price, \$7.50 (Canada, \$11.25)

Height:—5" Weight:— $2\frac{1}{2}$  lb.

This is a real universal electric motor of  $\frac{1}{10}$  H. P. at a speed of approximately 7,500 revolutions per minute. It will operate on either direct or alternating current of 110 volts up to 60 cycles.

This motor is very carefully constructed, the case being of a high-grade die cast metal, nickel plated and polished. It is mounted on a pressed steel, nickel-plated polished base.

Motor complete with cord and plug ready to be attached to any lamp socket.

### B-688 Three Speed Motor.

Retail Price, \$3.50 (Canada, \$5.25)

Height:— $3\frac{3}{4}$ " Weight:—2 lb.

The general construction of this motor is the same as B-686 but it is provided with two sets of gears, giving the motor three different speeds.

This motor is exceptionally strong and the power derived from the second gear shaft is sufficient to operate the Gilbert Miniature Machinery as well as any other combination of toy apparatus that can be driven with an electric motor.

All the small parts are nickel-plated. This motor represents the most complete toy power outfit imaginable and will fill all requirements.

### B-686 Motor.

Retail Price, \$2.00, (Canada \$3.00)

Height:— $2\frac{3}{4}$ " Weight:— $1\frac{3}{4}$  lb.

Although it will require only batteries or transformer current, this motor will drive a regular sewing machine.

It is the strongest and most dependable enclosed type motor on the market. It has brass bearings. The fields and armatures are laminated. The commutator is air cooled. Mounted on heavy cast iron base which is finished in black japan.

### B-687 Motor.

Retail Price, \$2.50 (Canada, \$3.75)

Height:— $2\frac{3}{4}$ " Weight:— $1\frac{3}{4}$  lb.

This is exactly the same motor as B-686 but has a reversible switch.

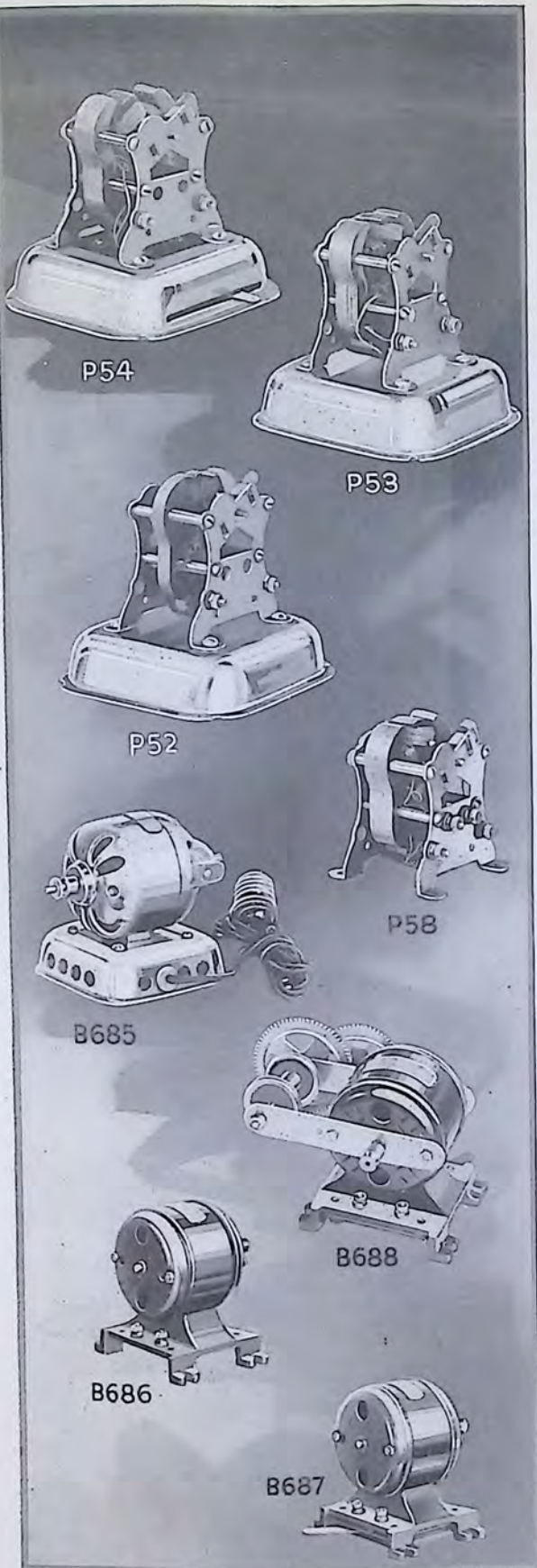

## GILBERT Toy Motors.

The most efficient, durable, and popular line of toy motors selling today. These motors are the result of the most careful designs created after innumerable experiments thoroughly testing many features which have finally made "Gilbert Motors" withstand the most thorough and severe tests. The boys demand a varied assortment in order to put into motion countless construction toy models, mechanical toys, etc., which they possess.

Guaranteeing you rapid turnovers and, therefore, profitable business, these motors are just what you need.

### P-73 Generator.

Retail Price, \$4.50 (Canada, \$6.75)

Height:— $4\frac{3}{4}$ " Weight:—3 lb.

Description:—Resembles highest grade type of Generator. Produces six volts open circuit at 3,000 revolutions per minute.

### P-82 Motor.

Retail Price, \$3.50 (Canada, \$5.25)

Height:— $3\frac{7}{8}$ " Weight:—2 lb.

Description:—Wound for battery use or Transformer and also has special reversing attachment. This is the only die-cast toy motor on the market. Motor nickel plated.

### P-56-B Motor.

Retail Price, \$3.00 (Canada, \$4.50)

Height:— $3\frac{7}{8}$ " Weight:—2 lb.

Description:—Connects direct to either alternating or direct current, 105 to 115 volts, 60 cycle. Furnished with five-foot cord and plug.

### P-56-C Motor.

Retail Price, \$5.00 (Canada, \$7.50)

Height:— $3\frac{7}{8}$ " Weight:—3 lb.

Description:—Universal toy motor. Operates on either alternating or direct current, 100 to 130 volts. Furnished with five-foot cord and plug. Motor nickel plated.

### Electric Thriller, No. 275.

Retail Price, \$1.25 (Canada, \$1.90)

Dimensions:— $4 \times 2\frac{3}{4}$ " Weight:— $2\frac{1}{2}$  lb.

This Electric Thriller is not only a practical medical instrument but also a toy very much appreciated by boys and girls.

It is very attractively finished in bright colors with all the small parts nickel-plated and polished. The whole mounted on a very neat and strong wooden base.

### P-59 Reverse Switch.

Retail Price, 75c. (Canada, \$1.15)

Size:— $4 \times 4$ " Weight:—7 oz.

Description:—Used to operate four-terminal toy motors either backward or forward. Can be directly attached to motor P-58 or connected at distance by using longer lengths of wire.

### P-61 Control Switch.

Retail Price, \$1.50 (Canada, \$2.25)

Size:— $4 \times 4$ " Weight:—7 oz.

Description:—Controls the speed of any toy motor. Has spring wound coil of high resistance wire mounted on well insulated frame. Controlled by movable lever similar to standard makes of rheostats. Has resistance of one ohm.

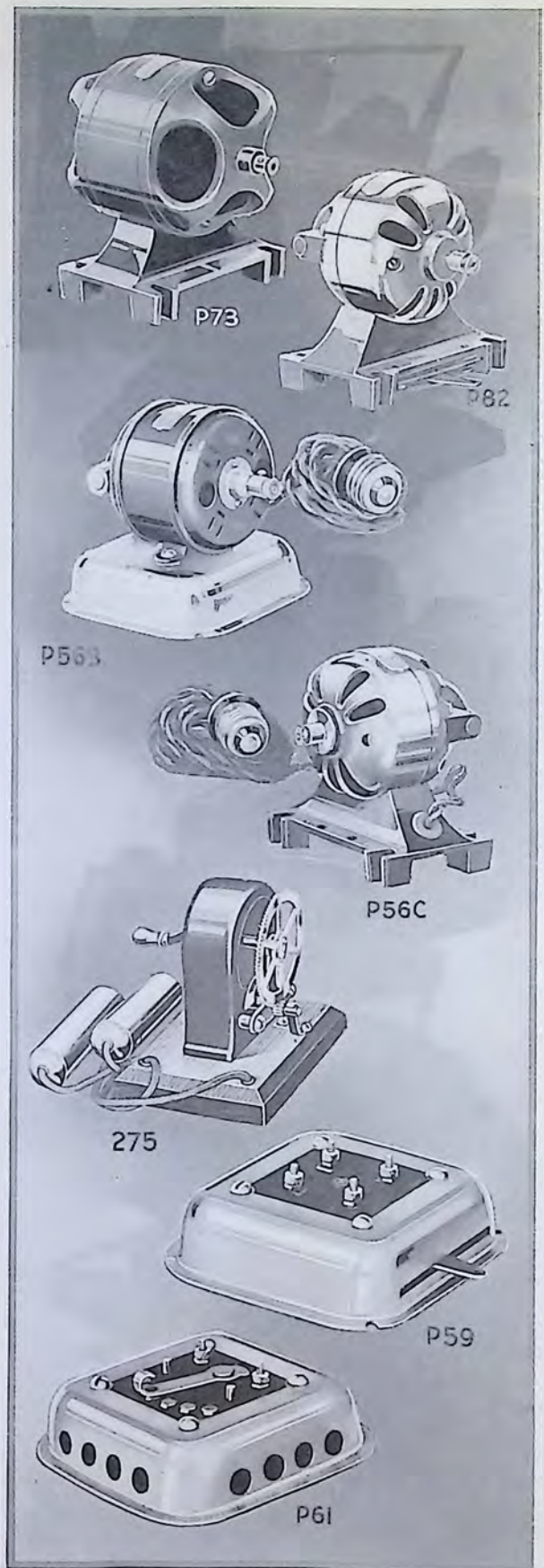

**GILBERT**

**Electrical Toy Accessories.**

These are wanted by the boy who operates construction toy models or electrically operated mechanical models, electric trains, etc. The Gear Box and Multi-Gear Motor give an unlimited variation of adjustable gearings; the Transformers have a wide range of variable voltage; while the Reverse Switch and Speed Control fit in exactly with what is needed by the boy in order to operate the various electrical toys according to his ideas of the real thing.

You will readily appreciate the wide field open for these items and you are missing many valuable sales unless you carry a liberal stock of the complete line.

**P-62 Gear Box.**

**Retail Price, 50c. (Canada, 75c.)**

Size:— $5\frac{3}{4}$  x 3 x 3".

Weight:—10 oz.

Description:—By mounting P-58 Motor on the two side plates and using Erector shaftings, pinion gears, gear wheels, etc., our regular Multi-Gear Motor, exactly the same as P-63 can be made.

**P-60-B Transformer.**

**Retail Price, \$3.25 (Canada, \$4.90)**

Size:— $3\frac{1}{2}$  x  $3\frac{3}{4}$  x  $2\frac{1}{2}$ ".

Weight:—2 lb. 12 oz.

Description:—Output can be varied from three to twenty volts; to be used only on alternating current. 110 volts, 60 cycle. Furnished with five-foot cord and plug.

**P-63 Multi-Gear Motor.**

**Retail Price, \$2.00 (Canada, \$3.00)**

Size:— $5\frac{3}{4}$  x 3 x 3".

Weight:—1 lb. 6 oz.

Description:—The Motor mounted between the steel plates is P-58 which can be easily detached. By using Erector shaftings, gearings, etc., this unit will drive every type of electrically operated toy.

**P-60 Transformer.**

**Retail Price, \$3.00 (Canada, \$4.50)**

Size:— $3\frac{1}{2}$  x  $3\frac{3}{4}$  x  $2\frac{1}{2}$ ".

Weight:—2 lb. 12 oz.

Description:—Operates on alternating current only, 110 volts, 60 cycle. Output is 4-8 and 12 volts. Furnished with five-foot cord and plug.

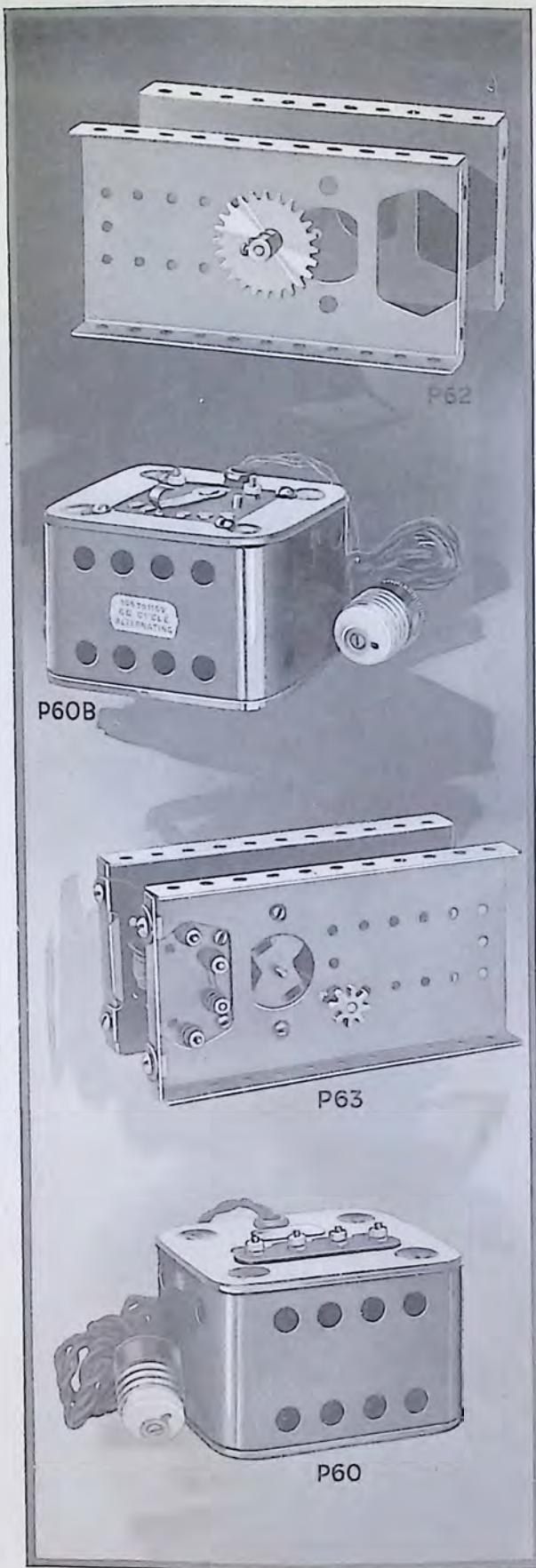

**GILBERT**  
**Mysto Magic.**

The steady, constant demand for something entirely different from the ordinary toys for boys has resulted in the development of this unusual line of Gilbert Mysto Magic.

Because of the fascination which every wide-awake boy has for Magical stunts seen on the stage, Mysto Magic has proved to be an unusually popular toy. Each and every trick has been selected from the viewpoint of the boy so that the various sets include only the most interesting and fascinating tricks.

The very same tricks which the boys see done on the stage can be repeated with Mysto Magic. Since the most mystifying tricks are the simplest they are easily mastered by boys who develop seemingly marvelous mysterious abilities.

The illustrated Manual of Instructions explaining all details is a part of each Outfit. Everything is told the boy, even including the "patter," how to make stage settings for a real entertainment which can be given in the parlors of homes, clubs, churches, Y. M. C. A.'s., etc. Suggestions include how to conduct the whole affair so that any average boy can readily make money giving Magic shows. There is also included in each set a Show Poster with space for name and date so that the boy can announce his Magic Show which is to be given at any particular time.

All sets except No. 2006 come in the individual Gilbert Toy sealed carton, with four color varnished label. No. 2006 packed in stained hardwood cabinet.

Previous seasons have fully proved the excellent selling qualities of Gilbert Mysto Magic. Compiled by a professional entertainer who knows what boys want, the Outfits have continually increased in popularity. Backed by strong national advertising in the leading publications, together with the highest quality dealer service in the way of demonstration allowances and display material, makes the handling of Gilbert Mysto Magic an A-1 proposition for every toy dealer.

## Mysto Magic Outfits.

### Mysto Magic No. 2001.

Retail Price, \$1.00. (Canada \$1.50.)

Box:—New Sealed Carton,  $8\frac{3}{4} \times 12\frac{1}{4} \times 1\frac{1}{4}$ "'. Weight:—1 lb.

Description:—Contains Show Poster, Magic Wand and Illustrated Manual describing each trick, some of which are as follows:

Marble Vase, Disappearing Handkerchief, Mysterious Discs, Multiplying Billiard Balls, Disappearing Coins, etc.

### Mysto Magic No. 2002.

Retail Price, \$2.00. (Canada \$3.00)

Box:—New Sealed Carton,  $8\frac{3}{4} \times 12\frac{1}{4} \times 1\frac{1}{4}$ "'. Weight:—1 lb. 5 oz.

Description:—Outfit includes Wand, Show Poster and Illustrated Manual describing all tricks, some of which are: Passe-Passe Coin Trick, Disappearing Coin, Vanishing Handkerchief, Multiplying Coins, Card Tricks, etc.

### Mysto Magic No. 2003.

Retail Price, \$3.00. (Canada \$4.50)

Box:—New Sealed Carton,  $8\frac{3}{4} \times 12\frac{1}{4} \times 2\frac{1}{4}$ "'. Weight:—2 lb. 3 oz.

Description:—Set includes Magician's Wand, Show Poster and Illustrated Manual describing each and every trick, some of which are the following:

Chinese Linking Rings, Multiplying Billiard Balls, Cigarette Vanisher, Passe-Passe Coin Tricks, Multiplying Coins, Disappearing Egg, etc.

### Mysto Magic No. 2004.

Retail Price, \$5.00. (Canada \$7.50)

Box:—New Sealed Carton,  $12\frac{1}{4} \times 8\frac{3}{4} \times 2\frac{3}{4}$ "'. Weight:—2 lb. 8 oz.

Description:—This set is made up of a show Poster, Magic Wand and Illustrated Manual of Instructions telling how to give Magic entertainments describing all tricks of which the following are a few:

Diminishing Billiard Ball, Disappearing Handkerchief, Chinese Linking Rings, Drum Head Tube, Card Tricks, etc.

### Mysto Magic No. 2006.

Retail Price, \$10.00 (Canada \$15.00)

Box:—Hard-wood cabinet  $13 \times 9 \times 3$ "'. Weight:—6 lb. 5 oz.

Description:—The best collection of amateur magic for giving complete entertainments; containing, Magician's Nickel-tipped Wand, Show Poster and Illustrated Manual giving complete instructions how to give a performance, including "patter," etc. Some of the tricks included are:

Spirit Slate, Siberian Transport Chain, Drumhead Tube, Handkerchief Cassette, Passe-Passe Coin Trick, etc.

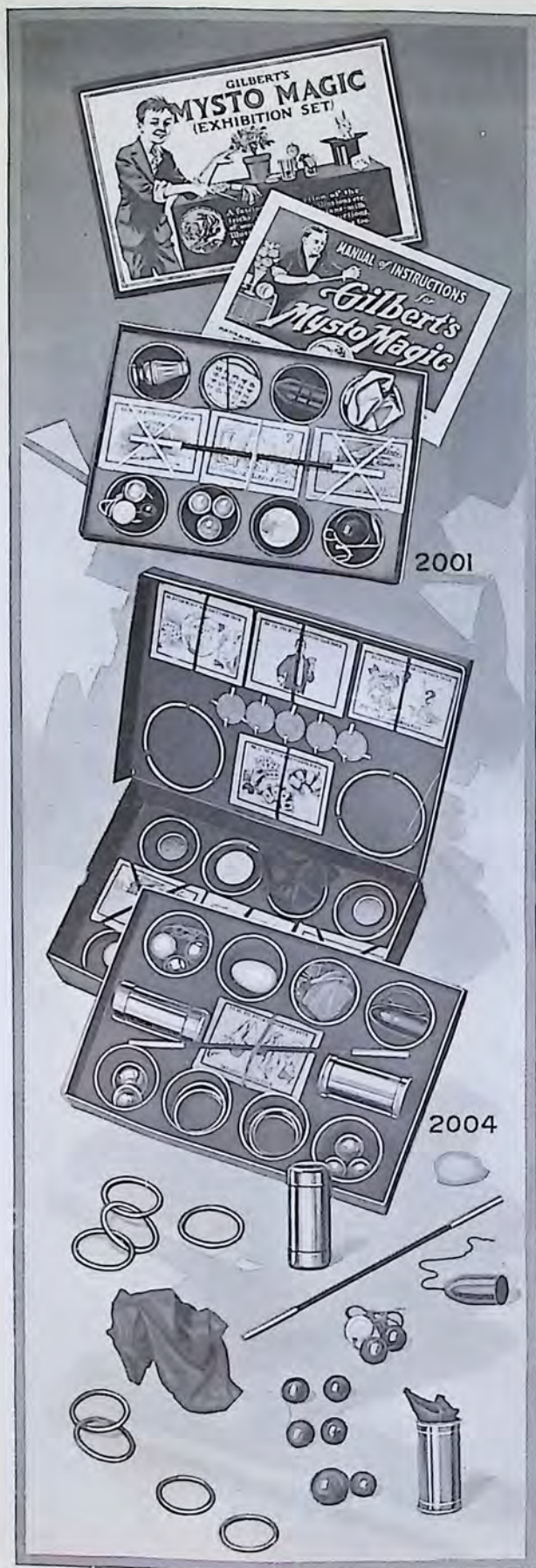

## GILBERT Puzzle Parties.

These unique outfits are attractively put up containing an unusually fine assortment of the most interesting and difficult Puzzles ever devised. Manual includes full instructions by illustration and description of each Puzzle, also telling how to give Puzzle Parties in the home. This is all worked out so as to be remarkably fascinating to children as well as grown-ups.

Gilbert Puzzle Parties and Gilbert Mysto Magic are so closely related because of their very nature that an assortment of one should always include the other. You will find the consumer demand for either Magic or Puzzles creates sales for the other.

### Puzzle Party No. 1029.

Retail Price, 25c. (Canada, 40c.)

Box:—New Sealed Carton,  $9\frac{1}{4} \times 5\frac{1}{4} \times \frac{7}{8}$ " . Weight:—8 oz.

Description:—Contains six interesting Puzzles with direction folder telling how to solve each one. Contains: Twin Rings, Heart, Question, Conjuring Rings, Three Rings.

### Puzzle Party No. 1030.

Retail Price, 50c. (Canada 75c.)

Box:—New Sealed Carton,  $10\frac{3}{4} \times 6\frac{3}{4} \times \frac{7}{8}$ " .  
Weight:—1 lb. 3 oz.

Description:—Contains an assortment of excellent Puzzles with big Illustrated Manual giving full directions and telling how to hold Puzzle Parties at home. Following are some of the Puzzles: Twin Rings, Nail, Spiral Wire and Three Links.

### Puzzle Party No. 1031.

Retail Price, \$1.00. (Canada \$1.50)

Box:—New Sealed Carton,  $12\frac{1}{4} \times 8\frac{3}{4} \times 1\frac{1}{4}$ " .  
Weight:—1 lb. 3 oz.

Description:—The most complete Puzzle Set ever made. Contains a good assortment of the most difficult Puzzles known, with big illustrated Manual giving full instructions telling how to hold Puzzle Parties at home. A few of the Puzzles are:

Star and Crescent, Key, Devil's Lock, Foxy Link, Horse Shoe, and Shamrock.

### Puzzle Mail Card.

This method of mounting individual Puzzles on cardboard which also gives full directions with illustration is a very popular item. These cards are scored in the center so that they can be folded over and mailed in an ordinary envelope.

Assortment of cards includes sixteen different Puzzles. A liberal quantity of these should be included with every order for Puzzle Party Sets.

Retail Price 10c. each. U. S. and Canada.

### Separate Tricks Cabinet.

The big demand for separate Magic Tricks and Puzzles is easily taken care of by this handy cabinet of Tricks. Each item is illustrated on cardboard beneath the glass top, making it a simple matter for the customer to choose the Tricks desired, also making the handling of this profitable business a simple thing for the dealer. When prominently displayed this Cabinet will mean continuous, profitable sales.

Retail Price, \$50.80. (Canada \$76.20)

Cabinet:—Hard-wood, stained, with glass top.  
Size:— $26\frac{1}{2} \times 18 \times 12\frac{1}{2}$ " . Weight:—46 lb.



**GILBERT**

**Mechanical Toys.**

These Gilbert Mechanical Toys are up to the highest perfection in workmanship, material and finish. They represent the most attractive mechanical toys now being made, being thoroughly tested and improved after years of experiments. There is positively nothing better on the toy market. With the scarcity of foreign mechanical toys, this line gives the dealer a field for sales from which he should continue to obtain valuable profits.

**Important features:**

1. Each toy lithographed in bright, attractive colors.
2. Each machine with lithographed driver.
3. Improved and mechanically correct spring wound motor.
4. Substantially made of heavy material.
5. Correct in design; realistic appearance.
6. Separately packed in lithographed boxes.

Our newest toys, Tumbling Clowns are unique and novel. Made of metal with the Clowns brightly lithographed in attractive colors. A slight push starts them tumbling over one another, with the bells which are attached, adding to the interest considerably. Packed in Board Box with Attractive Design.

**P-74 Ambulance.**

Retail Price, 85c. (Canada, \$1.30)

Length:—9½". Height:—5¾". Weight:—1 lb.

**P-76 Racer**

Retail Price, 85c. (Canada, \$1.30)

Length:—9¼". Height:—3½". Weight:—1 lb.

**P-78 Mail Wagon.**

Retail Price, 85c. (Canada, \$1.30)

Length:—9½". Height:—5¾". Weight:—1 lb.

**P-77 Truck.**

Retail Price, 50c. (Canada, 75c.)

Length:—10¼". Height:—3½". Weight:—1 lb.

**No. B-677 Tumbling Clown.**

Retail Price, 59c. (Canada, 89c.)

Length 15". Height 15". Weight 12 oz.

**No. B-678 Tumbling Clowns.**

Retail Price, \$1.25 (Canada, \$1.90)

Length 20". Height 15". Weight 1 lb.

**No. B-695 Swinging Bird.**

Eleven Different Designs of Birds and Animals.  
(Not Illustrated)

Retail Price, 59c. (Canada, 89c.)

Length over all, 36½". Weight 6 oz.

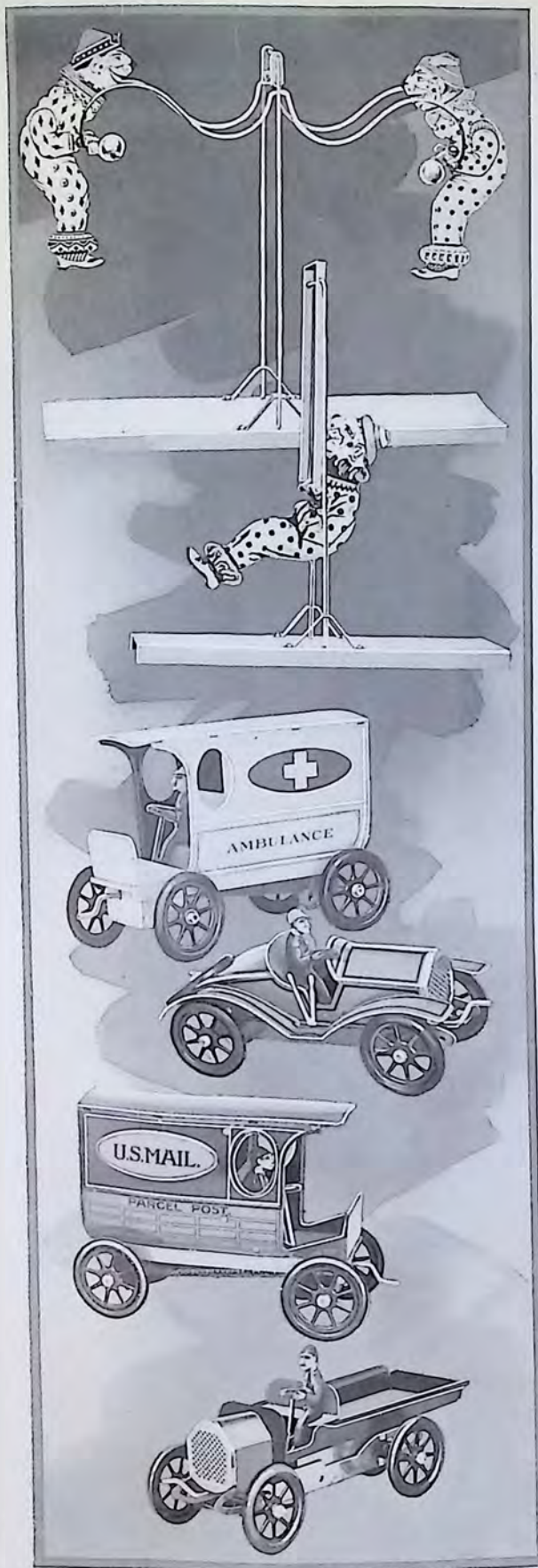

## Rattles and Floor Chimes.

Description:—These rattles and floor chimes are staunch, well built and strongly put together. They are staple toys, which sell at a good profit and for which there is always a demand. Rattles are furnished with black or white enameled handles. Floor chimes have red wheels with brightly nickel plated bells. They are supplied with wire handles or with wire yoke for pulling on a string. They are made to retail from ten cents to twenty-five cents and are sold in gross lots on a net price basis. Write for prices.

### No. 6101 Rattle.

3 Bells—Black Enameled Handle.

### No. 6102 Rattle.

Gong and 2 Bells—Black Enameled Handle.

### No. 6103 Rattle.

4 Bells—White Enameled Handle.

### No. 6104 Rattle.

2 Bells and Rubber Teething Ring.  
Black Enameled Handle.

### No. 6105 Rattle.

6 Bells—Black Enameled Handle.

### No. 6106 Rattle.

Gong, 2 Bells and Rubber Teething Ring  
Black Enameled Handle.

### No. 6107 Rattle.

4 Bells and Rubber Teething Ring.  
White Enameled Handle.

### No. 6108 Rattle.

8 Bells—White Enameled Handle.

### No. 6201 Floor Chime.

Large Gong—Wheel Diam. 3"—Wire Yoke.

### No. 6202 Floor Chime.

Large Gong—Wheel Diam. 3"—Wire Handle.

### No. 6203 Floor Chime.

3 Bells—Wheel Diam. 3"—Wire Yoke.

### No. 6204 Floor Chime.

3 Bells—Wheel Diam. 3"—Wire Handle.

### No. 6205 Floor Chime.

Double Gong—Length 6½ inches—Wire Handle.

### No. 6206 Floor Chime.

6 Bells—Length 6½"—Wire Handle.

### No. P-90 Floor Chime.

6 Bells—Wheel Diam. 3"—Wire Handle.

### No. P-91 Floor Chime.

12 Bells—Length 6½"—Wire Handle.

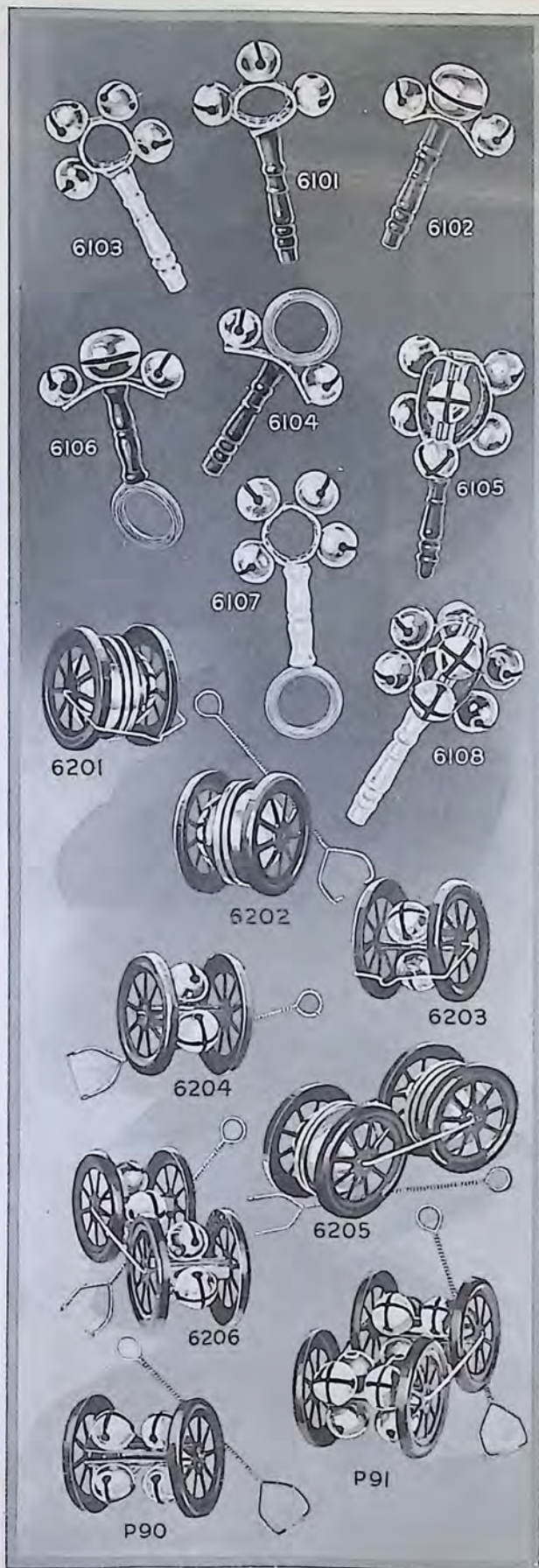

## Reins.

Every child, sometime in his life has a set of toy reins with which to "play horse" etc. They are a necessary and profitable item in every toy department. Gilbert reins are strongly and carefully made. Lines are of a composition leather, stained white and very durable. Bells are brightly nickel plated. They are furnished with different numbers of bells—to retail from ten cents to fifty cents. Sold in gross lots on a net price basis. Write for prices.

### No. 6001 Rein.

3 Bells—Length  $3\frac{1}{2}$  feet.

### No. 6002 Rein.

4 Bells—Length  $3\frac{1}{2}$  feet.

### No. 6003 Rein.

6 Bells—Length  $3\frac{1}{2}$  feet.

### No. 6004 Rein.

3 Bells—Colored Horse's Head.  
Length  $3\frac{1}{2}$  feet.

### No. 6005 Rein.

7 Bells—Colored Horse's Head.  
Length  $3\frac{1}{2}$  feet.

### No. 6006 Rein.

7 Bells—2 Large Rings.  
Length  $3\frac{1}{2}$  feet.

### No. 6007 Rein.

13 Bells—Length  $3\frac{1}{2}$  feet.

### No. 6008 Rein.

16 Bells—4 Small Rings.  
Length  $3\frac{1}{2}$  feet.

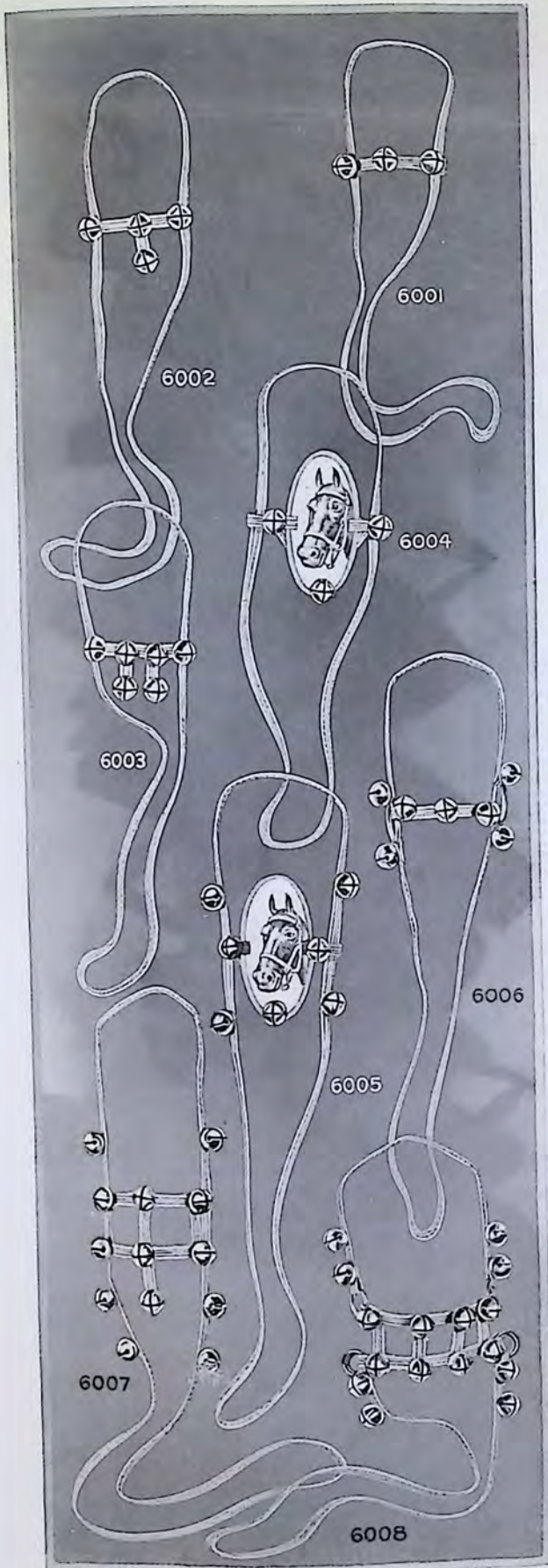

## GILBERT War Toys.

Due to the conditions of today, Gilbert War Toys offer you one of the best opportunities for excellent toy profits that there are. Boys and girls everywhere want practical Toys with which they can play war, and Gilbert War Toys meet this demand. Your customers are going to want them not only during the Holiday Season, but in the Summer Season as well. They offer you a means of making your Toy Department pay you a profit during its usually slow season.

We have improved and perfected these Gilbert War Toys—Gilbert Machine Gun, Submarine and Nurse's Outfit for the little girl—and they represent the best values possible. They are genuine in their realistic uses and are ideal for summer play.

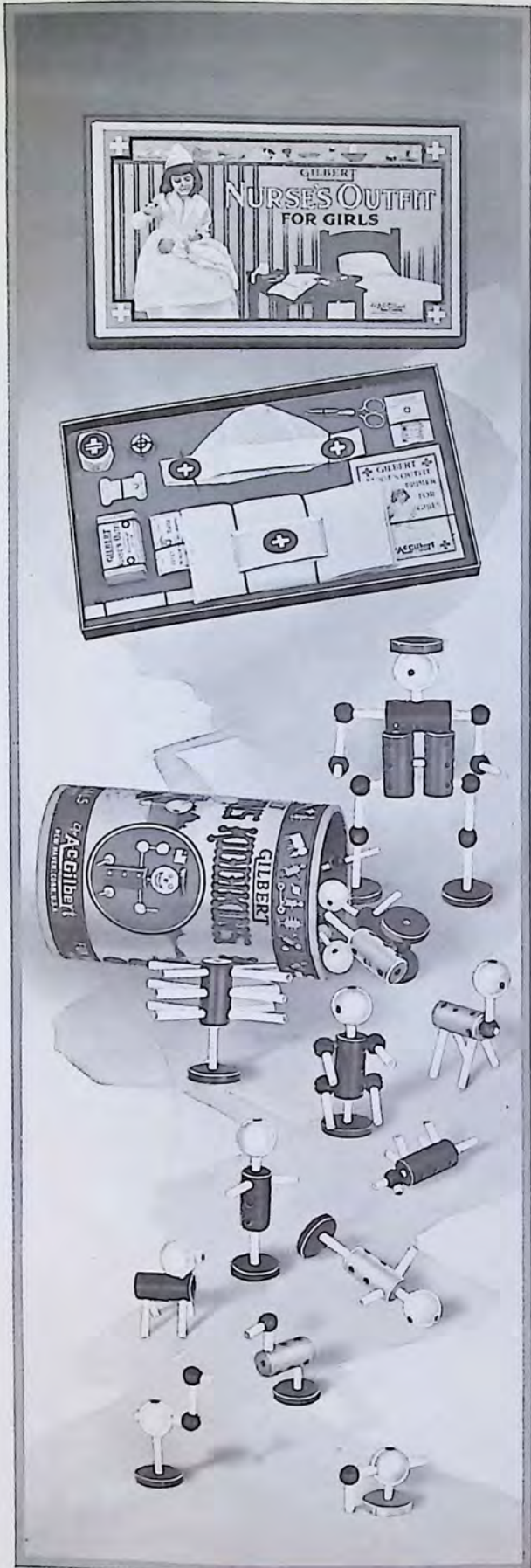

## GILBERT

### Nurse's Outfit for Girls.

A most timely girl's toy. Nothing could be of greater irresistible appeal to the little girl who is just at the age where she is imitating her favorite "grown-up" ladies. The set is a complete Nurse's Kit; including cap, apron, arm band, scissors, safety pins, absorbent cotton, adhesive tape, dental floss, vaseline, splints, etc. "First Aid Primer" included with each outfit is attractively illustrated and written in simple primer style, telling just how grown-up nurses do it.

There is a big demand for this popular girl's toy of the hour. Every dealer can cash in on these good sales the whole year 'round.

**Nurse's Outfit No. P-83.**

**Retail Price, \$1.95. (Canada, \$2.95)**

Box:—New Sealed Carton, 18 x 10 x 1¼".  
Weight:—1 lb. 9 oz.

## GILBERT Kiddikins.

A novel, keenly interesting and appealing toy for the child of three years and up. There is hardly a limit to the possibilities of what a child can make—animals, people, indoor and outdoor objects from their own childish realm.

The differently colored wood parts having the simplest method of putting together and taking apart makes "Kiddikins" ideally suitable for the youngest child who has learned to use his hands.

"Kiddikins" is one of the most popular and fastest selling "Gilbert Parcel Post Toys", being put up in the new cylinder cartons all ready for mailing.

**Kiddikin No. B-656.**

**Retail Price, 50c. (Canada, 75c.)**

Package:—Cylinder carton with light blue and yellow label.  
Height:—6". Diameter:—3¾". Weight:—7 oz.

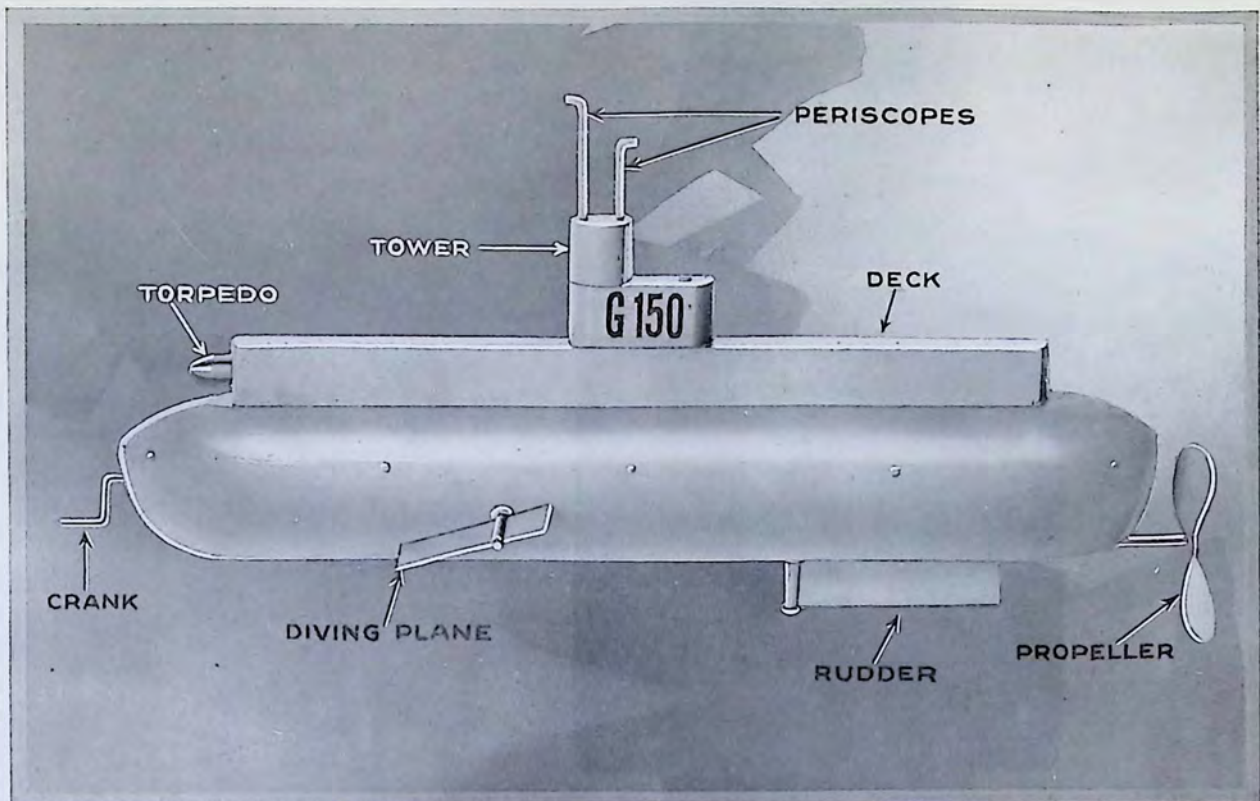

## GILBERT Diving Submarine.

Gilbert Diving Submarine is the most remarkable aquatic toy ever devised. It is an actual working miniature model of the history-making "U-Boat." It is difficult to imagine the youngster who will not be head-over-heels with delight for this Submarine Toy which actually dives under its own power, automatically shooting a torpedo and then coming to the surface.

It is equipped with strong, powerful spring motor, submerging planes, self-propelling torpedo, crank shaft, steel propeller, etc. It moves along either on the surface or beneath the surface of the water, identically like a real Submarine. The "G-150" is non-sinkable and always rises to the surface at the end of its voyage so that it cannot possibly be lost.

Hull is made of steel, with wood decks and tower, finished in battleship gray; this is one of the most attractive war toys ever made.

**Diving Submarine No. G-150.**

**Retail Price, \$1.50. (Canada \$2.25).**

Box:—Board Box attractively designed for display.

Length:—13½". Height:—7". Weight:—1 lb. 1 oz.

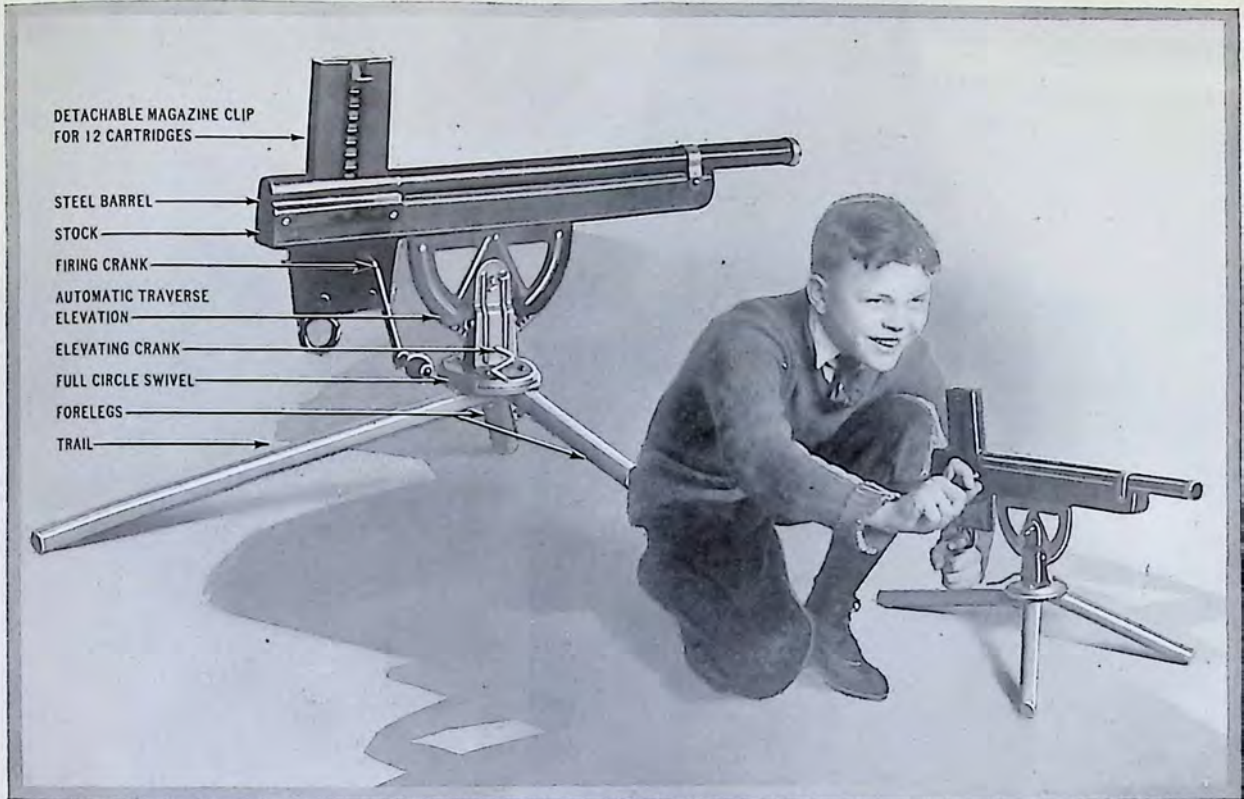

## GILBERT Machine Gun.

This Gilbert Rapid Firing Machine Gun is the real thing, being designed just as closely as possible after the famous Guns which are being used on the battlefields of the Great War.

This Gun works fast as lightning—ten shots per second. Bullets accurately aimed twenty-five to thirty feet. Detachable magazine clip holding ten cartridges makes a realistic veritable rain of bullets. The automatic traversed elevation and full circle swivel makes traverse and zone firing adjustable to every type of target whether on right or left flank, hill-top or valley, making the play battles for the youngsters actually realistic.

The Manual included with each Gun tells the boy how to form a Machine Gun Company with his playmates, the instructions giving real regulations for a Machine Gun Section just like the Regulars in the Army.

### THE BIG FEATURES.

Detachable Magazine Clip for ten cartridges. Steel Barrel.

Machine Gun Manual Containing full instructions to the Boy for Organizing a Machine Gun Section  
Firing Crank. Automatic Traversed Elevation. Full Circle Swivel, etc.

Live dealers are recognizing the big possibilities with this timely toy. Now is the time to get in on this good business.

**Gilbert Machine Gun No. B-654.**

Retail Price, \$3.25. (Canada \$4.90)

Box:—Board box with attractive battle scene design specially suitable for display.

Length:—28¼". Height:—15⅝". Weight:—3 lbs.

Finish:—Black Enmael and Nickel.

## “Gilbert Toy” Advertising.

Once Again, It will Completely Dominate the Toy Field.

Three things are responsible for the remarkable success of Gilbert Toys:—

- (1) Highest toy merit and quality.
- (2) Absolute fairness in our relations with dealers and the closest kind of co-operation.
- (3) Big, national advertising that has established “Gilbert Toys” in the minds of young and old alike as the most desirable and dependable toys that can be bought.

The Gilbert policy has always contemplated a big increase in toy sales from season to season.

And with this end in view, we have constantly added to Gilbert quality, to Gilbert co-operation, and to Gilbert advertising.

Last year's business was the biggest in the history of the Company.

It is our determination that the Gilbert Toy Business this year will once again rise above its high-water mark.

And so, we have planned an advertising campaign of greater magnitude and effectiveness than of any of our big campaigns of the past.

It will send tens of thousands of buyers into the stores of dealers whose windows proclaim the fact that the nationally famous “Gilbert Toys” are sold within.

On the opposite page are shown some of the magazines of great circulation that will carry the “Gilbert Toy” message this year into more than twenty million homes. Be identified with this biggest advertising campaign in the history of the toy business!

Put Gilbert Toys in stock, and Gilbert advertising will point, in your locality, directly to *your* store.



These magazines carry the story of "Gilbert Toys" to millions.

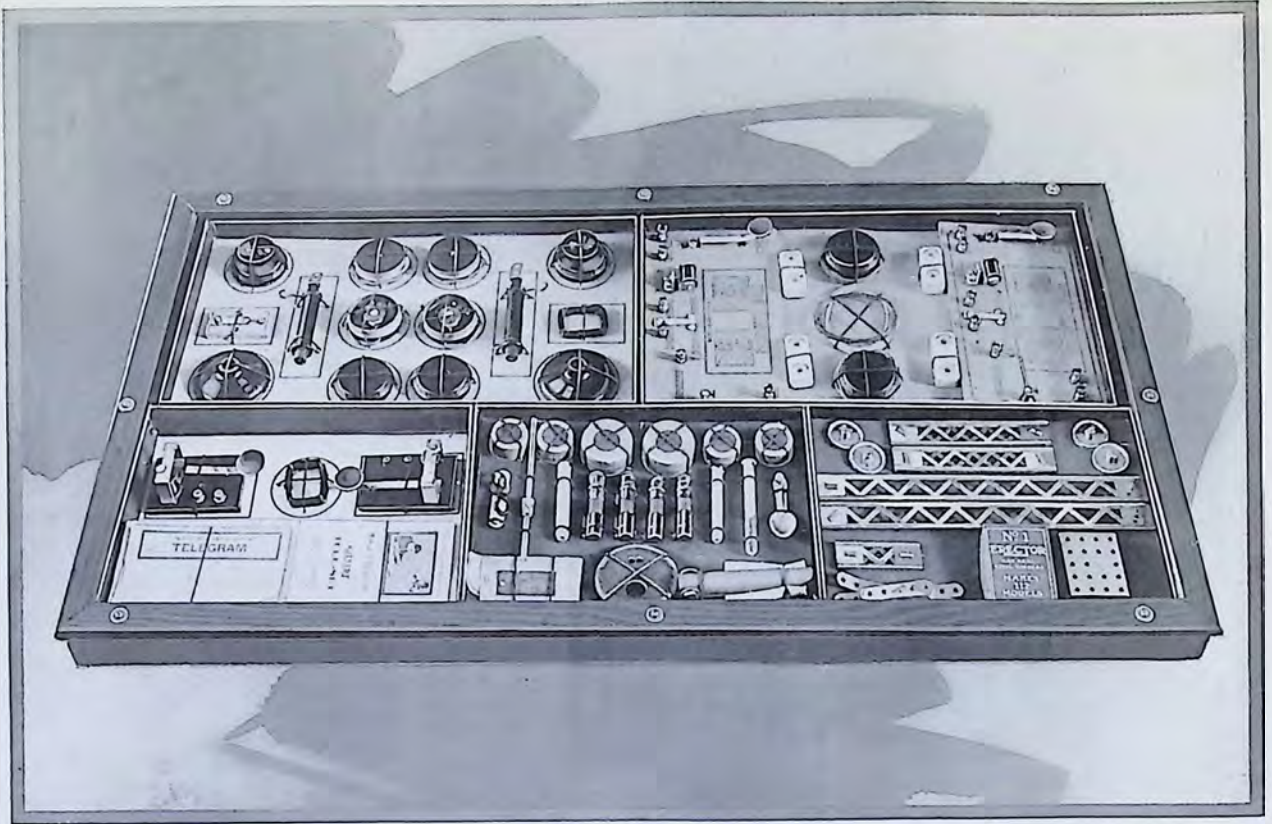

## Special Cabinets for Gilbert Toys.

We have, for a number of years, been trying to improve the way in which Gilbert Toys are shown to the consumer and have at last arrived at a plan which we feel sure solves the problem. Every dealer who buys a demonstration of a certain quantity is furnished with two of these cabinets for his counter.

They are made of hard wood frames, stained a beautiful oak, and fitted with glass tops. They are built exactly the right size to hold sets of different Gilbert Toys which come in standard size cartons. The cover of the Set is to be taken off and the contents only displayed. This allows the set to be shown up to the best advantage but does away with the "handling evil" which has cost you large sums of money yearly.

We think this is one of the best ideas for Toy displaying yet devised and we will be very glad to outline our proposition to you.

Illustration shows one of these cabinets containing sample sets.

# Gilbert Toys

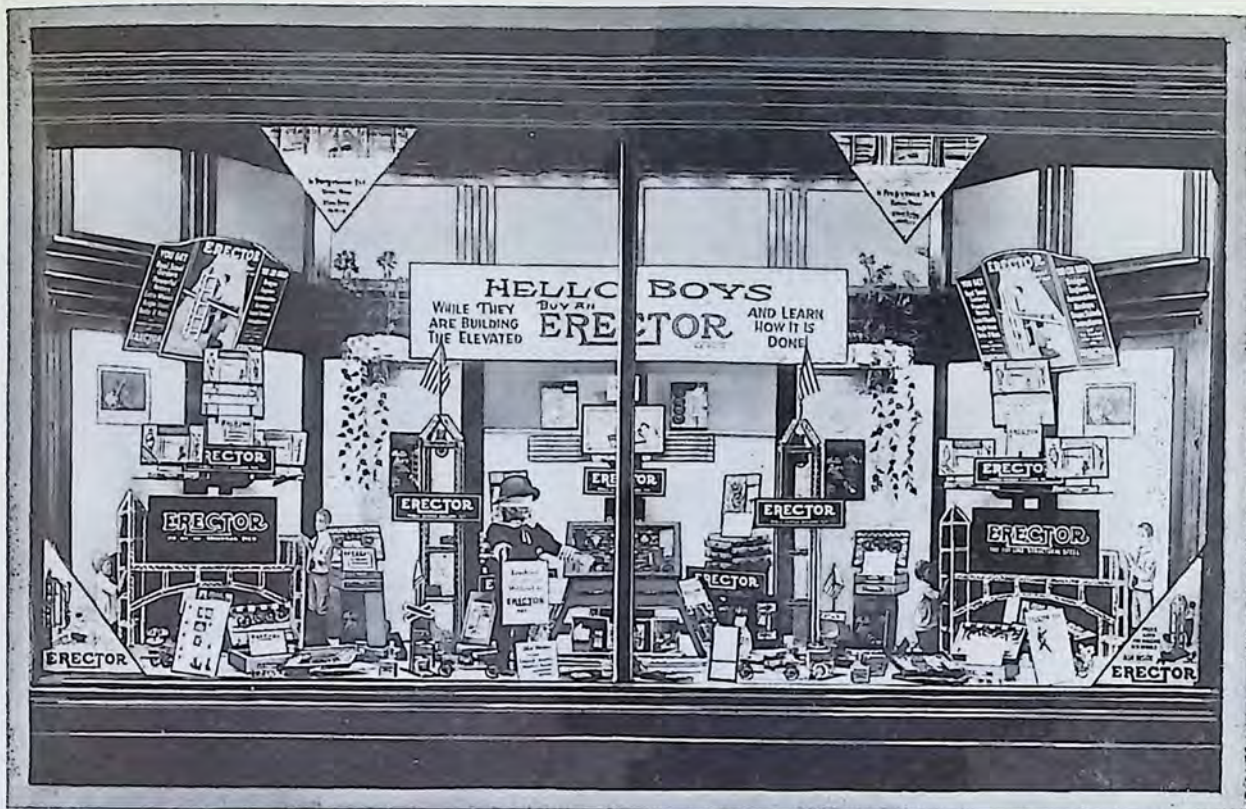

GILBERT TOY WINDOW.

(Designed by T. Kenneth Harveson for McCurdy Bros., Philadelphia, Penna.)

## Store Demonstrations.

A good demonstration during the holiday season will make "Gilbert Toys" the biggest selling toy item in your store.

The majority of "Gilbert Toys" give the dealer the advantage of our strongly established and perfected method of demonstration. Our trained organization of Directors of Demonstrators teach your special demonstrator or clerk how to obtain the maximum results for you. This is a mighty important part of our service. Your demonstrators are given a thorough coaching by our Director of Demonstrators from headquarters well in advance of the holiday season.

This service is absolutely free, varying in amount only according to the quantity of your order. We give you an allowance for the amount of the salary for a demonstrator.

A "Gilbert Toy" demonstration in your store will make you more money than several ordinary clerks. "Gilbert Toys" mean a quality proposition to you.

The kind of boys who are interested in "Gilbert Toys" are critical. "Gilbert Toy" service material, therefore, is always expensive and of the highest class. The lithographed signs, window cutouts, and other forms of our service are supplied the trade liberally and are so complete that they pretty near approach perfection in silent salesmanship.

This service is all yours for the asking.

TOYS THAT ARE GENUINE

## INDEX.

TOYS	Page	TOYS	Page
Ambulance (Mechanical Toy) .....	25	Nurses Outfit .....	29
Bell Toys .....	26-27	Phono-Set .....	11
Circular Saw .....	15	Puzzle Mail Card .....	24
Chemistry Outfits .....	9	Puzzle Parties .....	24
Control Switch .....	20	Racer (Mechanical Toy) .....	25
Drill Press .....	15	Rattles .....	26
Drill Press with Motor .....	16	Reins .....	27
Electrical Sets .....	10-12-13	Reverse Switch .....	20
Electrical Toys .....	10	Scroll or Jig Saw .....	15
Emery and Buffing Wheel .....	15	Scroll or Jig Saw with Motor .....	16
Emery and Buffing Wheel with Motor .....	16	Submarine .....	30
Erector .....	6-7-8	Surface Grinder or Sander .....	15
Erector Accessory Sets .....	7	Swinging Birds .....	25
Erector Master Engineer Set .....	8	Tele-Set .....	11
Erector Parts Cabinets .....	8	Thriller .....	20
Erector Sets .....	7	Transformers .....	21
Floor Chimes .....	26	Tumbling Clowns .....	25
Generator .....	20	Truck (Mechanical Toy) .....	25
Kiddikins .....	29	War Toys .....	28-29-30-31
Machine Gun .....	31	Wireless Telegraph Outfit .....	11
Machine Shops .....	17-18	Wood Turning Lathe .....	15
Mail Wagon (Mechanical Toy) .....	25	Wood Turning Lathe with Motor .....	16
Mechanical Toys .....	25		
Miniature Machinery .....	14-15-16-17-18	<b>MISCELLANEOUS</b>	
Motors .....	19-20-21	Advertising .....	32-33
Multi-Geared Box .....	21	Display Material .....	34-35
Multi-Geared Motor .....	21	Engineering Institute .....	5
Mysto Magic .....	22-23-24	History of Organization .....	4
Mysto Magic Separate Trick Cabinet .....	24	Store Demonstrations .....	34-35
Mysto Magic Sets .....	23	Window Displays .....	35



